

Operating Instructions

VEGALOG 571 AA

Output card analogue

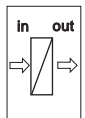
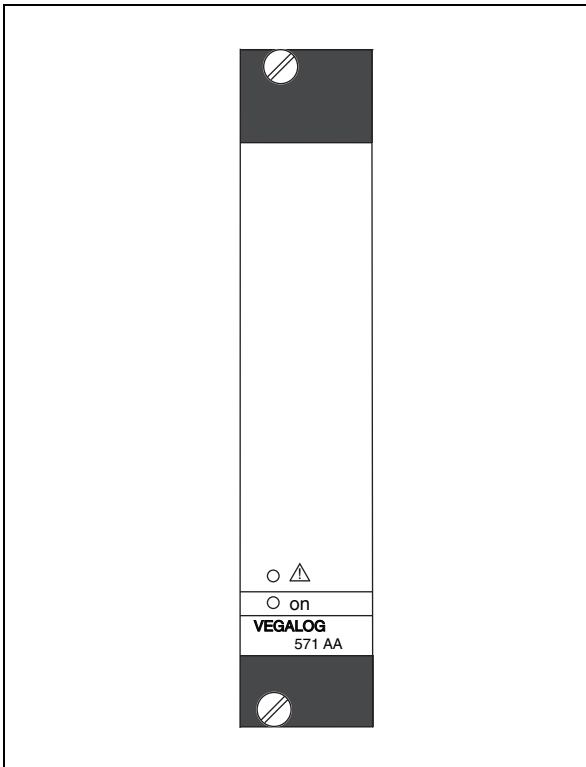

Contents

- 1 About this document**
 - 1.1 Function 3
 - 1.2 Target group 3
 - 1.3 Symbolism used 3
- 2 For your safety**
 - 2.1 Authorised personnel 4
 - 2.2 Appropriate use 4
 - 2.3 Warning about misuse 4
 - 2.4 CE conformity 4
 - 2.5 Environmental instructions 5
- 3 Product description**
 - 3.1 Configuration 6
 - 3.2 Principle of operation 6
 - 3.3 Operation 6
 - 3.4 Storage and transport 7
- 4 Mounting**
 - 4.1 General instructions 8
 - 4.2 Module 8
 - 4.3 Coding 8
- 5 Connecting to power supply**
 - 5.1 Preparing the connection 11
 - 5.2 Connection cable 11
 - 5.3 Wiring plan 12
- 6 Set up**
 - 6.1 Indicating and adjustment elements 13
- 7 Maintenance and fault rectification**
 - 7.1 Maintenance 14
 - 7.2 Fault rectification 14
 - 7.3 Instrument repair 15
- 8 Dismounting**
 - 8.1 Dismounting procedure 16
 - 8.2 Disposal 16
- 9 Supplement**
 - 9.1 Technical data 17
 - 9.2 Dimensions 19

1 About this document

1.1 Function

This operating instructions manual has all the information you need for quick setup and safe operation. Please read this manual before you start setup.

1.2 Target group

This operating instructions manual is directed to trained, qualified personnel. The contents of this manual should be made available to these personnel and put into practice by them.

1.3 Symbolism used



Information, tip, note

This symbol indicates helpful additional information.



Caution: If this warning is ignored, faults or malfunctions can result.

Warning: If this warning is ignored, injury to persons and/or serious damage to the instrument can result.

Danger: If this warning is ignored, serious injury to persons and/or destruction of the instrument can result.



Ex applications

This symbol indicates special instructions for Ex applications.



List

The dot set in front indicates a list with no implied sequence.



Action

This arrow indicates a single action.



Sequence

Numbers set in front indicate successive steps in a procedure.

2 For your safety

2.1 Authorised personnel

All operations described in this operating instructions manual must be carried out only by trained specialist personnel authorised by the operator. For safety and warranty reasons, any internal work on the instruments must be carried out only by personnel authorised by the manufacturer.

2.2 Appropriate use

The AA card (**Ausgang Analog**, i.e. output analog) provides together with the VEGALOG 571 processing system ten 0/4 ... 20 mA outputs.

2.3 Warning about misuse

Inappropriate or incorrect use of the instrument can give rise to application-specific hazards, e.g. vessel overfill or damage to system components through incorrect mounting or adjustment.

2.4 General safety instructions

VEGALOG 571 AA is a high-tech instrument requiring the strict observance of standard regulations and guidelines. The user must take note of the safety instructions in this operating instructions manual, the country-specific installation standards (e.g. the VDE regulations in Germany) as well as all prevailing safety regulations and accident prevention rules.

2.5 CE conformity

The VEGALOG 571 AA(Ex) module card is in CE conformity with EMVG (89/336/EWG) and LVD (73/23/EWG).

Conformity has been judged according to the following standards:

- EMC:
 - Emission EN 50081-2
 - Susceptibility EN 50082-1
- LVD: EN 61010

2.6 Environmental instructions

Protection of the environment is one of our most important duties. That is why we have introduced an environment management system with the goal of continuously improving company environmental protection. The environment management system is certified according to DIN EN ISO 14001.

Please help us fulfil this obligation by observing the environmental instructions in this manual:

- Chapter "*Storage and transport*"
- Chapter "*Disposal*"

3 Product description

3.1 Configuration

Scope of delivery

The scope of delivery encompasses:

- 19" module card VEGALOG 571 AA
- Documentation
 - this operating instructions manual

3.2 Principle of operation

Area of application

The AA card (**A**usgang **A**nalog, i.e. output analogue) provides together with the VEGALOG 571 processing system ten 0/4 ... 20 mA outputs. These can be used for transmission of the measuring results to the following instruments:

- Indicating instruments
- Characteristics recorder
- Controller
- PLC

Physical principle

The AA card makes the processing results available via up to ten analogue currents in the range of 0 ... 20 mA. A scaling as well as the definition as rising or falling characteristics can be set via the adjustment software.

Power supply

The module card is powered via the common power supply unit of the VEGALOG system.

You can find detailed information on the power supply in the "*Technical data*" in the "*Supplement*".

3.3 Operation

The operation of VEGALOG 571 is carried out via a PC which can be connected via the RS232 interface of the CPU. As an alternative, connection via Ethernet and VEGACOM 558 is possible.

The adjustment software PACTware™ with the corresponding DTMs is installed under Windows™ and ensures easy configuration of measuring systems as well as parameter adjustment of connected VEGA sensors. For this purpose, PACTware™ provides a clear adjustment interface with menu structure, window technology and graphic support. In addition, online help is available which describes the available functions

and parameter adjustment options. For earlier VEGALOG systems with CPU software 1.xx, the previous software VVO (VEGA Visual Operating) must be used for operation.

3.4 Storage and transport

Packaging

Your instrument was protected by packaging during transport. Its capacity to handle normal loads during transport is assured by a test according to DIN EN 24180.

The packaging of standard instruments consists of environment-friendly, recyclable cardboard. For special versions, PE foam or PE foil is also used. Dispose of the packaging material via specialised recycling companies.

Storage and transport temperature

- Storage and transport temperature see "*Supplement - Technical data - Ambient conditions*"
- Relative humidity 20 ... 85 %

4 Mounting

4.1 General instructions

The module cards of VEGALOG 571 can only be mounted into the 19" carrier BGT LOG 571. It is provided with a special bus board for data transmission between CPU and the individual peripheral cards (LOGBUS). The carrier is designed for mounting into a switching cabinet or 19" housing.

The plug position for the individual cards is individually selectable, the system saves the card positions when switching on.



Note:

The plug positions must not be changed after the parameter adjustment because measurement loops that have already been set up would otherwise have to be reconfigured.

4.2 Module

Installation instructions

Setup a module for the VEGALOG 571 AA card. You will find the description in the operating instructions manual "*CPU and carrier*".

4.3 Coding

A mechanical coding system avoids later interchanging of the various module cards in the carrier.

The coding system consists of:

- two coded pins in the female multipoint connector
- two holes in the male multipoint connector of the respective component

The coded pins are attached to the module.

Equip the female multipoint connector with the two coded pins according to the "*Coding chart*" and "*Position of the coded pins*". The function coding points out that these are module cards of VEGALOG. The instrument coding is used to differentiate between the individual module cards.

The male multipoint connectors of the individual module cards point to the holes suiting the pin positions.

	Instrument coding	Function coding
CPU card	a1	c3
EP card	a3	c3 and c23 with Ex
AA card	a5	c3
AR card	a7	c3
AT card	a9	c3
EA card	a11	c3
VEGACOM 557	a27	c3, c11
VEGACOM 558	a29	c11
VEGASTAB 593	--	--

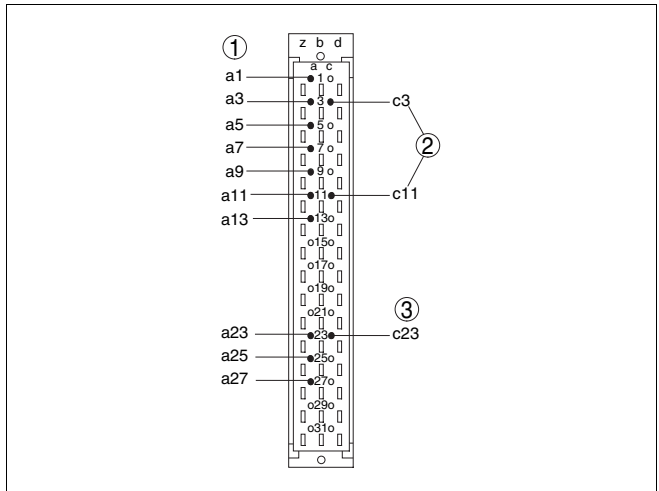

Fig. 1: Positioning of the coded pins on the male multipoint connector

- 1 Instrument coding
- 2 Function coding
- 3 Ex coding

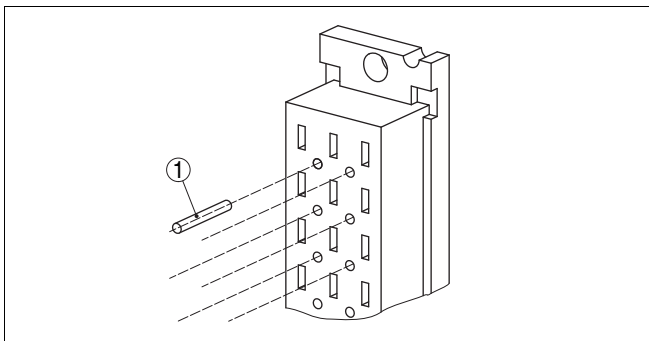

Fig. 2: Detail coded pin mounting
 1 Coded pin

5 Connecting to power supply

5.1 Preparing the connection

Note safety instructions

Always observe the following safety instructions:

- Connect only in the complete absence of line voltage
- If overvoltage surges are expected, overvoltage arresters should be installed

Take note of safety instructions for Ex applications



In hazardous areas you should take note of the appropriate regulations, conformity and type approval certificates of the sensors and power supply units.

Select power supply

The module card is powered via the common power supply unit of the VEGALOG system.

You can find detailed information on the power supply in the "Technical data" in the "Supplement".

5.2 Connection cable

Selecting the connection cable

Power supply is connected with standard cable acc. to the national installation standards.

To connect 4 ... 20 mA instruments, standard two-wire cable without screen can be used. If electromagnetic interference is expected which is above the test values of EN 61326 for industrial areas, screened cable should be used.

Cable screening and grounding

Connect the cable screen on both ends to ground potential. The screen must be connected (low impedance) on the 4 ... 20 mA instrument to the potential equalisation.

If potential equalisation currents are expected, the screen connection on the side of VEGALOG 571 AA must be made via a ceramic capacitor (e.g. 1 nF, 1500 V). The low frequency potential equalisation currents are thus suppressed, but the protective effect against high frequency interference signals remains.

Select connection cable for Ex applications



Take note of the corresponding installation regulations for Ex applications. In particular, make sure that no potential equalisation currents flow over the cable screen. In case of grounding on both sides this can be achieved by the use of a capacitor or a separate potential equalisation.

The total capacitance of the cable and of all capacitors must not exceed 10 nF in Ex applications.

5.3 Wiring plan

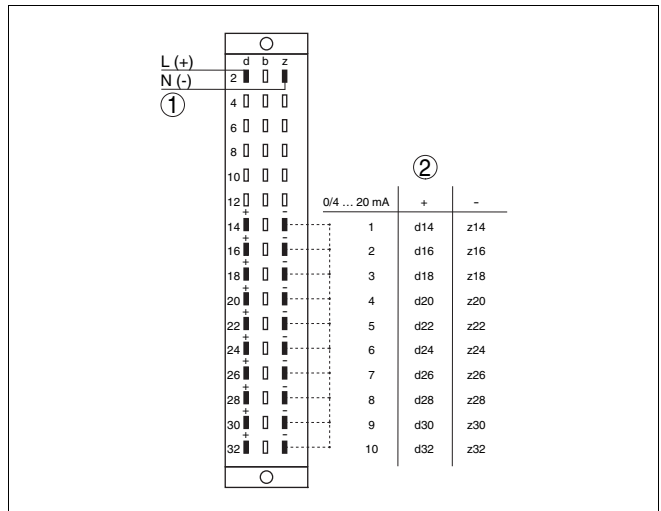

Fig. 3: VEGALOG 571 AA¹⁾

1 Power supply for VEGALOG 571 AA

2 4 ... 20 mA outputs



Information:

The outputs are only floating for voltage supply, among each other they are connected by a common ground.

¹⁾ Broken lines = Connections on the AA card.

6 Set up

6.1 Indicating and adjustment elements

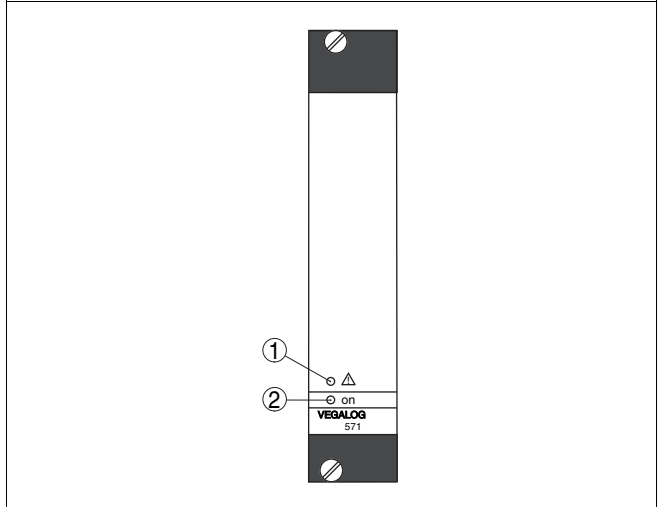

Fig. 4: Indicating and adjustment elements

- 1 LED for fault signal
- 2 LED for operating voltage

Description of the status LEDs

- LED fault signal [1]
 - flashes in case of communication problems on the LOGBUS
 - lights during initialisation and during the self-test
 - lights permanently during a hardware error
- LED operating voltage [2]
 - lights when voltage supply is on

The module cards of the VEGALOG system have no own adjustment elements. All adjustment measures are carried out with the PC through the adjustment software PACTware™. Setup information is available in the operating instructions manual "VEGALOG 571 CPU" as well as in the online help of PACTware™.

7 Maintenance and fault rectification

7.1 Maintenance

When used as directed in normal operation, the module card VEGALOG 571 AA is completely maintenance-free.

7.2 Fault rectification

Causes of malfunction

VEGALOG 571 AA offers maximum reliability. Nevertheless faults can occur during operation. These may be caused by the following, e.g.:

- Measured value of the sensor not correct
- Voltage supply
- Interference on the cables

Fault rectification

The first measures to be taken are checking the input/output signal as well as processing failure messages. The diagnostic information are updated cyclically in a 5 sec. pattern.

PACTware™ with the suitable DTM offers comprehensive diagnostics options. The integrated online help offers you additional information. In many cases, these causes can be thus determined and faults can be rectified.

24 hour service hotline

If these measures are not successful, you can call the VEGA service hotline in urgent cases under the phone no. **+49 1805 858550**.

The hotline is available to you 7 days a week round-the-clock. Since we offer this service world-wide, the support is only available in the English language. The service is free of charge, only the standard telephone costs will be charged.

Fault messages via LED status indication

The operating condition of the CPU and peripheral cards is displayed via the status LEDs in the front plate.

- LED failure message (red)
 - flashes in case of communication problems on the LOGBUS
 - lights during initialisation and during the self-test
 - lights permanently during a hardware error
- LED operating voltage (green)
 - lights when voltage supply is on

7.3 Instrument repair

If a repair is necessary, please proceed as follows:

You can download a return form (23 KB) from our homepage www.vega.com under: "*Downloads - Forms and Certificates - Repair form*".

By doing this you help us carry out the repair quickly and without having to call back for needed information.

- Print and fill out one form per instrument
- Clean the instrument and pack it damage-proof
- Attach the completed form and possibly also a safety data sheet to the instrument
- Please request the address for the return shipment from the VEGA agency serving you.

8 Dismounting

8.1 Dismounting procedure

**Warning:**

Before dismounting, be aware of dangerous process conditions such as e.g. pressure in the vessel, high temperatures, corrosive or toxic products etc.

Take note of chapters "*Mounting*" and "*Connecting to power supply*" and carry out the listed steps in reverse order.

8.2 Disposal

The instrument consists of materials which can be recycled by specialised recycling companies. We use recyclable materials and have designed the electronic modules to be easily separable.

WEEE directive 2002/96/EG

This instrument is not subject to the WEEE directive 2002/96/EG and the respective national laws (in Germany, e.g. ElektroG). Pass the instrument directly on to a specialised recycling company and do not use the municipal collecting points. These may be used only for privately used products according to the WEEE directive.

Correct disposal avoids negative effects to persons and environment and ensures recycling of useful raw materials.

Materials: see "*Technical data*"

If you cannot dispose of the instrument properly, please contact us about disposal methods or return.

9 Supplement

9.1 Technical data

General data

Series	19" module card for BGT LOG 571
Dimensions	W = 25.4 mm (1 in), H = 128.4 mm (5.06 in), D = 166 mm (6.54 in)
Weight	approx. 400 g (0.882 lbs)

Voltage supply

Operating voltage (PIN d2, z2)	24 V DC (18 ... 36 V)
Power consumption	max. 9 W

Electrical connection

Module card	Multipoint connector according to DIN 41612, series F, 48-pole (d, b, z) with coding hole
Module in the carrier BGT LOG 571	Suitable female multipoint connector according to DIN 41612 with connection via standard connection technologies

Current outputs

Quantity	10 outputs
Function	analogue output of the processing results
Range	0/4 ... 20 mA
Resolution	0.05 % of range (10 μ A)
Max. load	750 Ohm
Load-dependent error at 750 Ohm	0.5 % (100 μ A)
Linearity error	0.025 % of range
Temperature error	0.025 %/10 k of range

Displays

LED displays	
– Status indication operating voltage	1x LED green
– Status indication fault signal	1x LED red

Ambient conditions

Ambient temperature	-20 ... +60 °C (-4 ... +140 °F)
Storage and transport temperature	-20 ... +80 °C (-4 ... +176 °F)

Electrical protective measures

Protection mounted in BGT LOG 571

- | | |
|--|-------|
| – front side completely equipped or covers | IP 40 |
| – Upper and lower side | IP 20 |
| – Wiring side | IP 00 |

Protection class I (in carrier BGT LOG 571)

Overvoltage category II

Electrical separating measures

Galvanic separation according to VDE 0106, part 1²⁾

- Reference voltage

between voltage supply, LOGBUS connection and current outputs

250 V

²⁾ All current outputs have a common reference potential (GND).

9.2 Dimensions

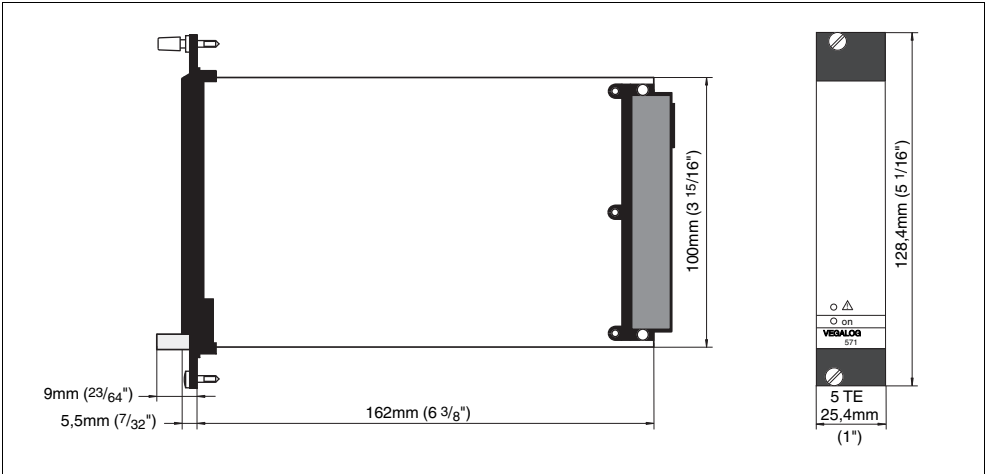

Fig. 5: Dimensions VEGALOG 571 AA



VEGA Grieshaber KG
Am Hohenstein 113
77761 Schiltach
Germany
Phone +49 7836 50-0
Fax +49 7836 50-201
E-mail: info@de.vega.com
www.vega.com



All statements concerning scope of delivery, application, practical use and operating conditions of the sensors and processing systems correspond to the information available at the time of printing.

© VEGA Grieshaber KG, Schiltach/Germany 2006