

Menu plan

VEGAMET 514V

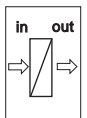
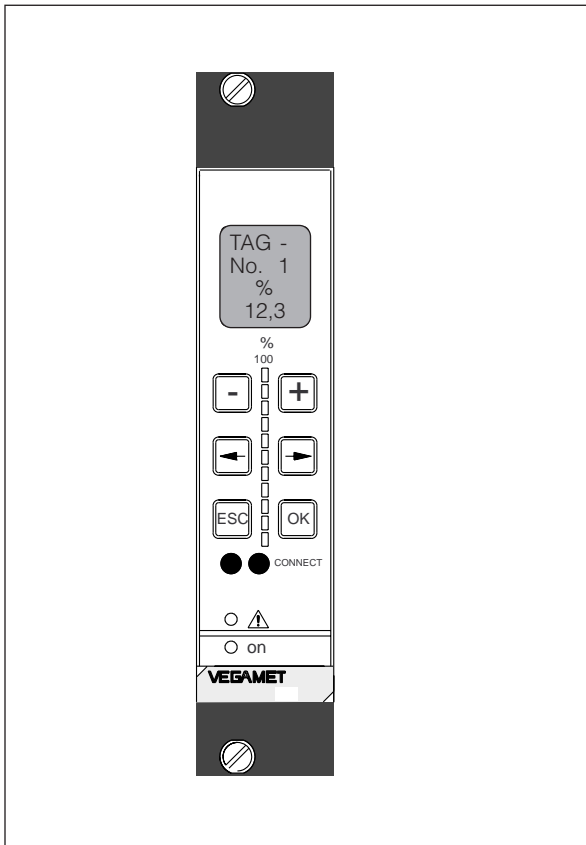

For adjustment of the signal conditioning instruments VEGAMET 514 V two menus are available:

the „Reduced menu“ and the „Extended menu“ (see following pages).

As factory setting „Reduced menu“ is activated.

The most important adjustment steps (e.g. adjustment, adjustment integration time, simulation...) can be carried out in the „Reduced menu“.

When you want to move to the „Extended menu“ (e.g. to edit linearisation curves) proceed as follows:

- Move with the OK-key and the arrow keys to the menu point „Menu mode reduced“.
- Push the + key twice.
- The display shows now „Menu mode extended“.
- Now push the OK-key to save the adjustment.

Language
English

In white letters you see the parameters which can be modified with the + or - key and which can be saved with the OK-key.

Param.
TAG-
No. 1

Bolt print / italic are the sensor or measured value information which cannot be modified in this position.

Relay
outp. 2

Light grey menu points are only displayed if necessary (dependent on the adjustments in other menus).

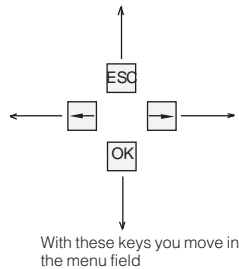

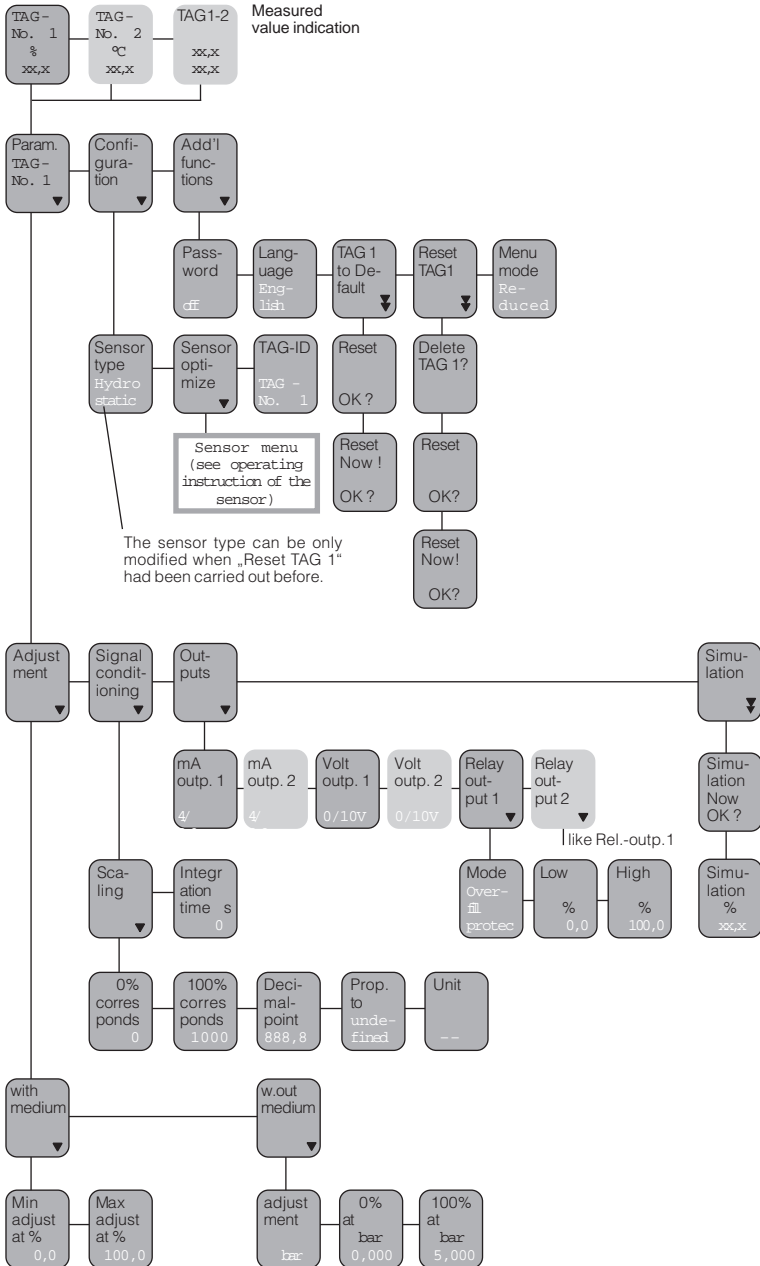

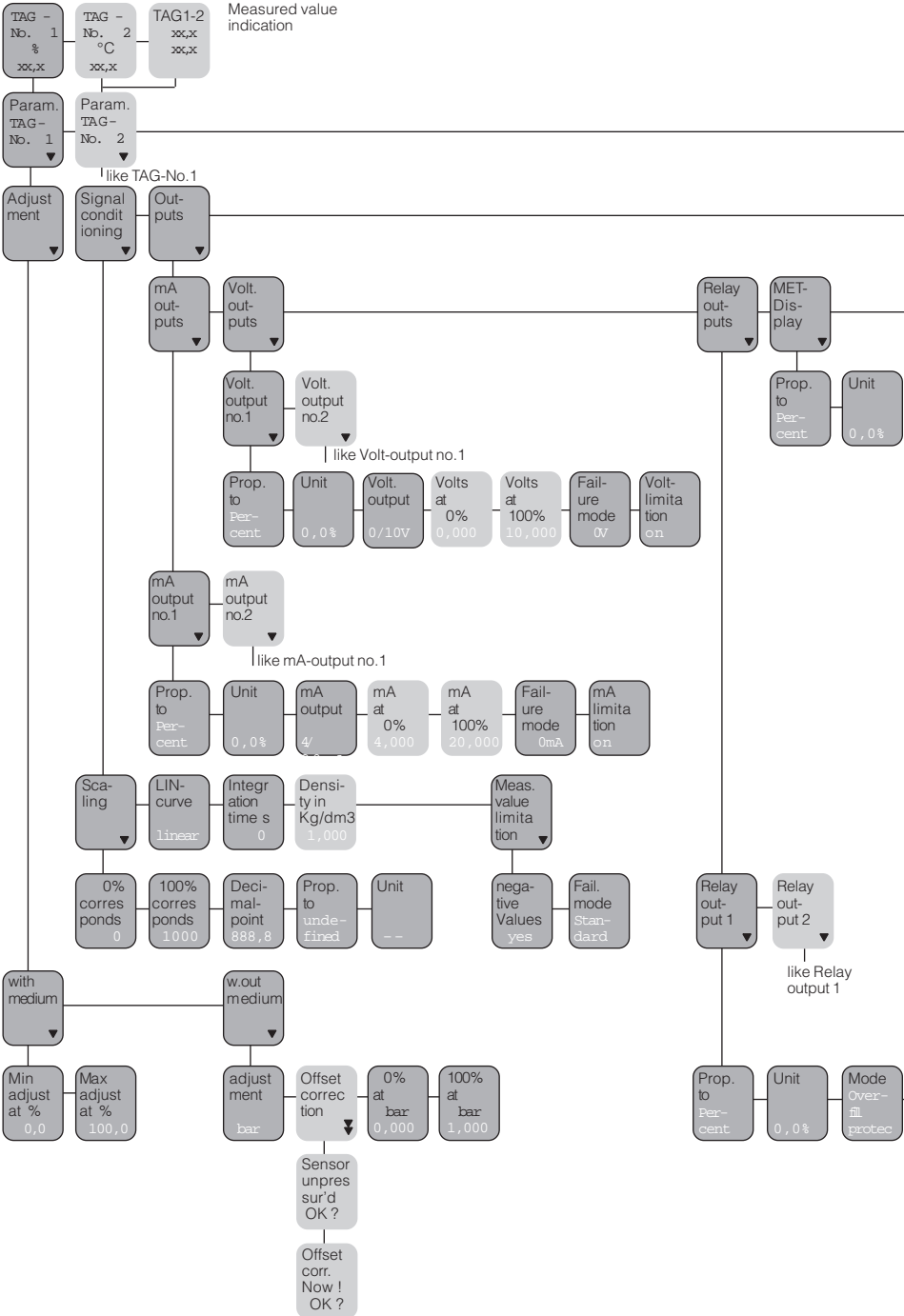

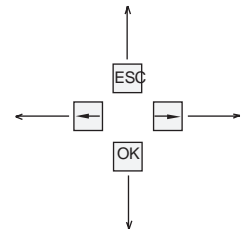
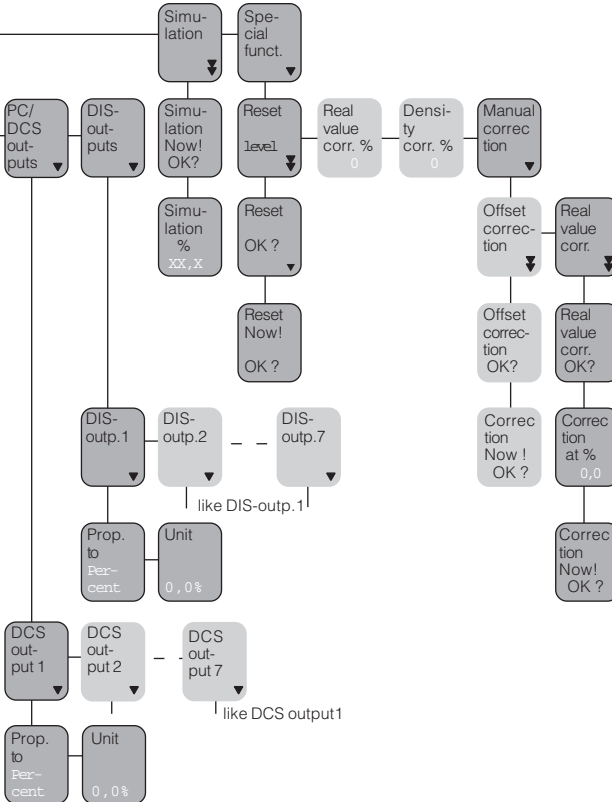

With these keys you move in the menu field

Sensor-type
hydro-static

Bolt print / italic are the sensor or measured value information which cannot be modified in this position.

Language
English

In white letters you see the parameters which can be modified with the + or - key and which can be saved with the OK-key.

mA
at 100%
20,000

Light grey menu points are only displayed if necessary (dependent on the adjustments in other menus).

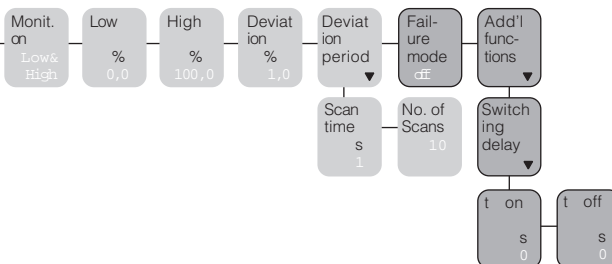

<-
previous
page

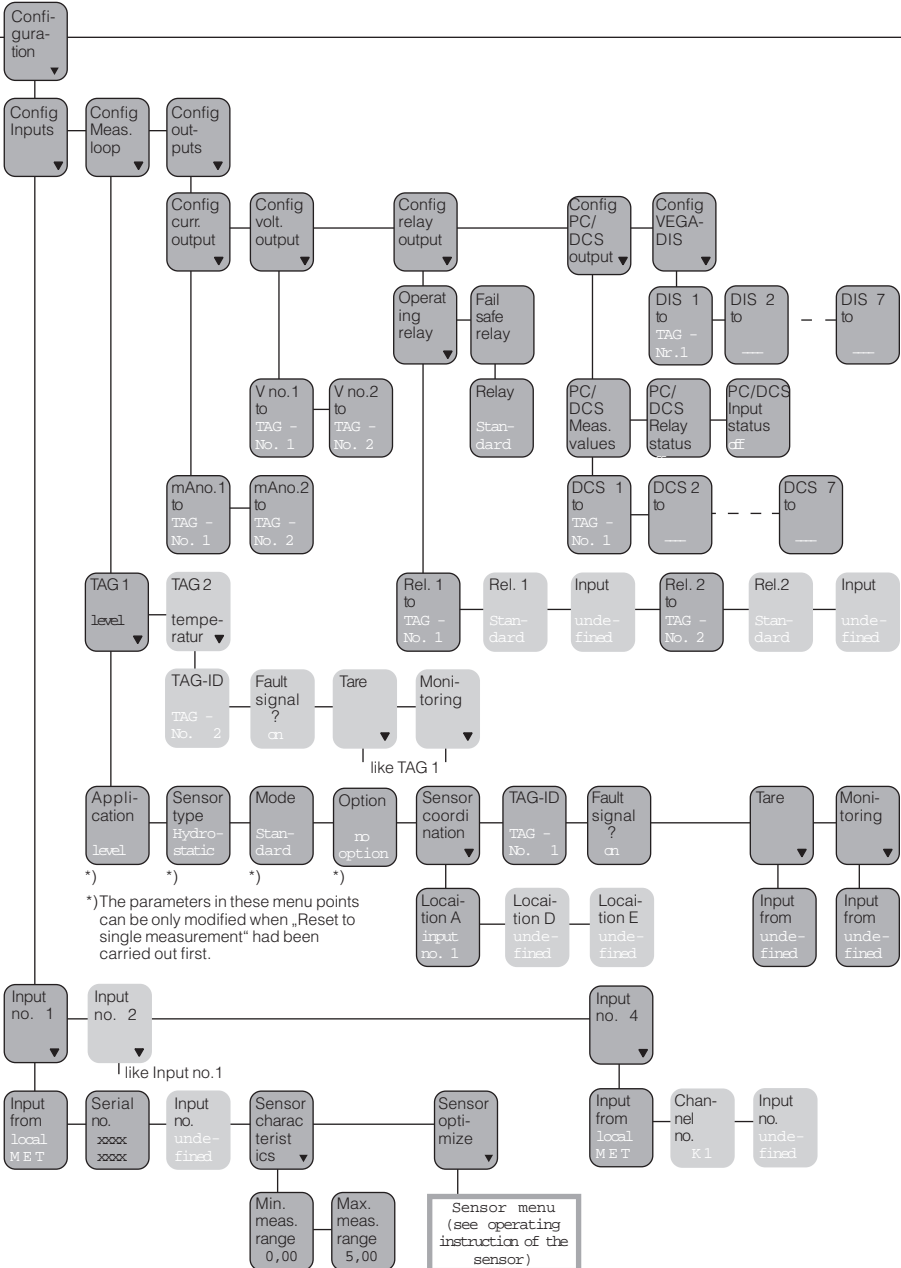

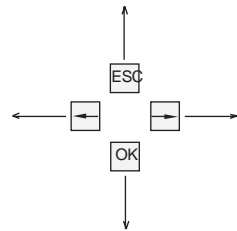

With these keys you move in the menu field

Sensor-type
hydro-*static*

Bolt print / italic are the sensor or measured value information which cannot be modified in this position.

Language
English

In white letters you see the parameters which can be modified with the + or - key and which can be saved with the OK-key.

mA
at
100%
20,000

Light grey menu points are only displayed if necessary (dependent on the adjustments in other menus).

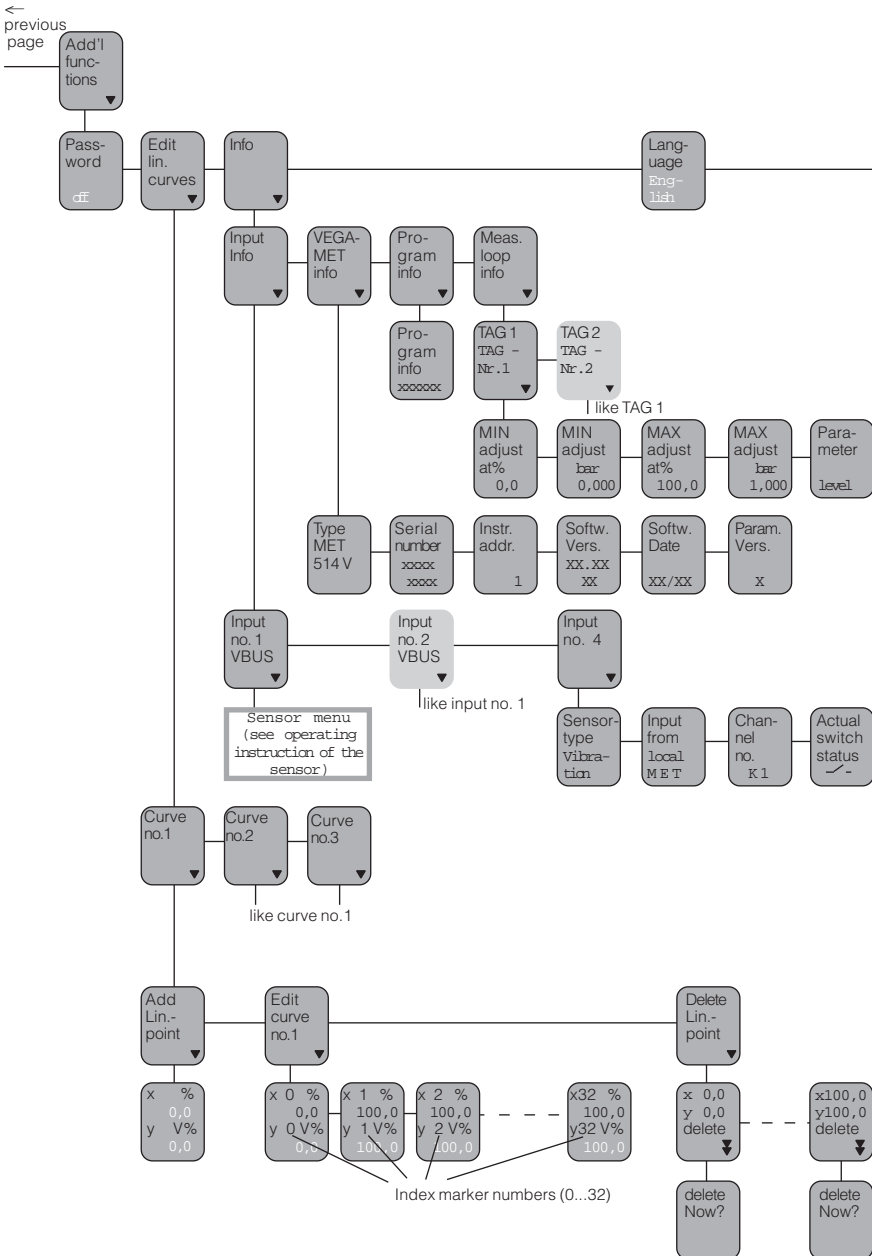

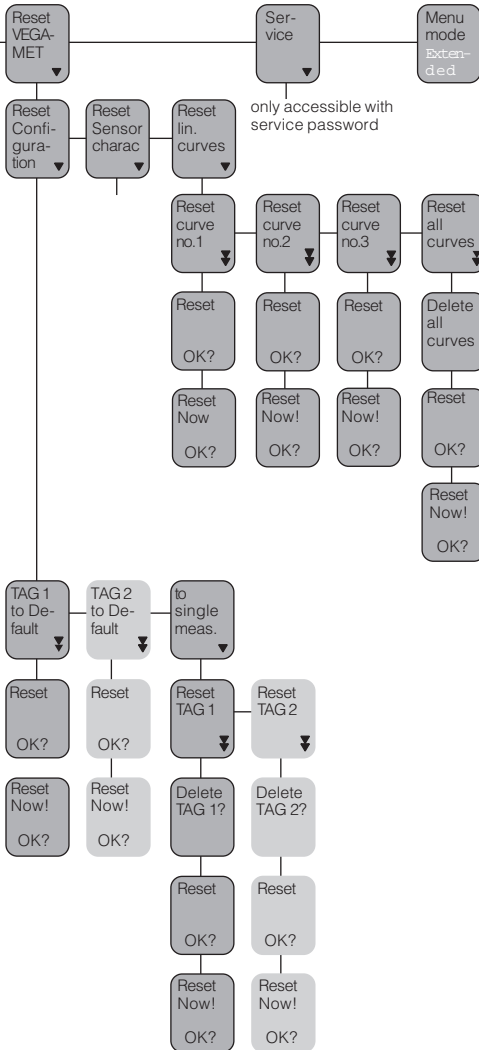

only accessible with service password

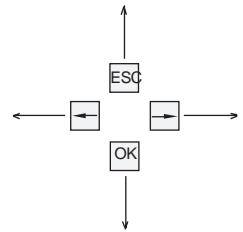

With these keys you move in the menu field

Sensor-type
hydro-static

Bolt print / italic are the sensor or measured value information which cannot be modified in this position.

Language
English

In white letters you see the parameters which can be modified with the + or - key and which can be saved with the OK-key.

mA at 100%
20,000

Light grey menu points are only displayed if necessary (dependent on the adjustments in other menus).

VEGA

VEGA Grieshaber KG
Am Hohenstein 113
D-77761 Schiltach
Phone (0 78 36) 50 - 0
Fax (0 78 36) 50 - 201
e-mail vega@vega-g.de

