

# Quick setup guide

Pressure transmitter with chemical seal

## VEGABAR 81

Modbus and Levelmaster protocol



Document ID: 46304



**VEGA**

# Contents

- 1 For your safety ..... 3**
  - 1.1 Authorised personnel ..... 3
  - 1.2 Appropriate use ..... 3
  - 1.3 Warning about incorrect use ..... 3
  - 1.4 General safety instructions ..... 3
  - 1.5 EU conformity ..... 4
  - 1.6 Permissible process conditions ..... 4
  - 1.7 NAMUR recommendations ..... 4
  - 1.8 Environmental instructions ..... 4
- 2 Product description ..... 6**
  - 2.1 Configuration ..... 6
- 3 Mounting ..... 7**
  - 3.1 General instructions for use of the instrument ..... 7
  - 3.2 Ventilation and pressure compensation ..... 7
- 4 Connecting to power supply and bus system ..... 8**
  - 4.1 Connecting ..... 8
  - 4.2 Wiring plan ..... 9
- 5 Set up the sensor with the display and adjustment module ..... 11**
  - 5.1 Insert display and adjustment module ..... 11
  - 5.2 Parameter adjustment - Quick setup ..... 11
  - 5.3 Parameter adjustment - Extended adjustment ..... 13
  - 5.4 Menu overview ..... 14
- 6 Supplement ..... 16**
  - 6.1 Technical data ..... 16



**Information:**

This quick setup guide enables quick setup and commissioning of your instrument.

You can find supplementary information in the corresponding, more detailed Operating Instructions Manual as well as the Safety Manual that comes with instruments with SIL qualification. These manuals are available in the download area of "[www.vega.com](http://www.vega.com)".

**Operating instructions VEGABAR 81 - Modbus and Levelmaster protocol: Document-ID 46293**

Editing status of the quick setup guide: 2019-04-02

# 1 For your safety

## 1.1 Authorised personnel

All operations described in this documentation must be carried out only by trained, qualified personnel authorised by the plant operator.

During work on and with the device, the required personal protective equipment must always be worn.

## 1.2 Appropriate use

The VEGABAR 81 is a pressure transmitter for process pressure and hydrostatic level measurement.

You can find detailed information about the area of application in chapter "*Product description*".

Operational reliability is ensured only if the instrument is properly used according to the specifications in the operating instructions manual as well as possible supplementary instructions.

## 1.3 Warning about incorrect use

Inappropriate or incorrect use of this product can give rise to application-specific hazards, e.g. vessel overfill through incorrect mounting or adjustment. Damage to property and persons or environmental contamination can result. Also, the protective characteristics of the instrument can be impaired.

## 1.4 General safety instructions

This is a state-of-the-art instrument complying with all prevailing regulations and directives. The instrument must only be operated in a technically flawless and reliable condition. The operator is responsible for the trouble-free operation of the instrument. When measuring aggressive or corrosive media that can cause a dangerous situation if the instrument malfunctions, the operator has to implement suitable measures to make sure the instrument is functioning properly.

During the entire duration of use, the user is obliged to determine the compliance of the necessary occupational safety measures with the current valid rules and regulations and also take note of new regulations.

The safety instructions in this operating instructions manual, the national installation standards as well as the valid safety regulations and accident prevention rules must be observed by the user.

For safety and warranty reasons, any invasive work on the device beyond that described in the operating instructions manual may be carried out only by personnel authorised by the manufacturer. Arbitrary conversions or modifications are explicitly forbidden. For safety reasons, only the accessory specified by the manufacturer must be used.

To avoid any danger, the safety approval markings and safety tips on the device must also be observed and their meaning read in this operating instructions manual.

## 1.5 EU conformity

The device fulfils the legal requirements of the applicable EU directives. By affixing the CE marking, we confirm the conformity of the instrument with these directives.

You can find the EU conformity declaration on our website under [www.vega.com/downloads](http://www.vega.com/downloads).

## 1.6 Permissible process conditions

For safety reasons, the instrument must only be operated within the permissible process conditions. You can find detailed information on the process conditions in chapter "*Technical data*" as well as on the type label.

The permissible process pressure range is specified by "MWP" (Maximum Working Pressure) on the type label, see chapter "*Structure*". The MWP takes the element of the measuring cell and processing fitting combination with the weakest pressure into consideration and may be applied permanently. The specification refers to a reference temperature of +20 °C (+68 °F). It also applies when a measuring cell with a higher measuring range than the permissible pressure range of the process fitting is installed order-related.

In order to prevent damage to the device, the test pressure may only exceed the specified MWP briefly by 1.5 times at reference temperature. The pressure stage of the process fitting as well as the overload resistance of the measuring cell are taken into consideration here (see chapter "*Technical Data*").

In addition, a temperature derating of the process fitting, e. g. with flanges, can limit the permissible process pressure range according to the respective standard.

## 1.7 NAMUR recommendations

NAMUR is the automation technology user association in the process industry in Germany. The published NAMUR recommendations are accepted as the standard in field instrumentation.

The device fulfils the requirements of the following NAMUR recommendations:

- NE 21 – Electromagnetic compatibility of equipment
- NE 53 – Compatibility of field devices and display/adjustment components
- NE 107 – Self-monitoring and diagnosis of field devices

For further information see [www.namur.de](http://www.namur.de).

## 1.8 Environmental instructions

Protection of the environment is one of our most important duties. That is why we have introduced an environment management system with the goal of continuously improving company environmental protection. The environment management system is certified according to DIN EN ISO 14001.

Please help us fulfil this obligation by observing the environmental instructions in this manual:

- Chapter "*Packaging, transport and storage*"
- Chapter "*Disposal*"

## 2 Product description

### 2.1 Configuration

#### Type label

The type label contains the most important data for identification and use of the instrument:



Fig. 1: Layout of the type label (example)

- 1 Instrument type and product code
- 2 Field for approvals
- 3 Power supply and signal output, electronics
- 4 Technical data
- 5 Order number
- 6 Serial number of the instrument
- 7 QR code
- 8 Symbol of the device protection class
- 9 ID numbers, instrument documentation
- 10 Reminder to observe the instrument documentation

#### Serial number - Instrument search

The type label contains the serial number of the instrument. With it you can find the following instrument data on our homepage:

- Product code (HTML)
- Delivery date (HTML)
- Order-specific instrument features (HTML)
- Operating instructions and quick setup guide at the time of shipment (PDF)
- Order-specific sensor data for an electronics exchange (XML)
- Test certificate (PDF) - optional

Move to "[www.vega.com](http://www.vega.com)" and enter in the search field the serial number of your instrument.

Alternatively, you can access the data via your smartphone:

- Download the VEGA Tools app from the "Apple App Store" or the "Google Play Store"
- Scan the Data Matrix code on the type label of the instrument or
- Enter the serial number manually in the app

## 3 Mounting

### 3.1 General instructions for use of the instrument

#### Protection against moisture

Protect your instrument against moisture ingress through the following measures:

- Use a suitable connection cable (see chapter "*Connecting to power supply*")
- Tighten the cable gland or plug connector
- When mounting horizontally, turn the housing so that the cable gland or plug connector point downward
- Lead the connection cable downward in front of the cable entry or plug connector

This applies mainly to outdoor installations, in areas where high humidity is expected (e.g. through cleaning processes) and on cooled or heated vessels.

To maintain the housing protection, make sure that the housing lid is closed during operation and depending on the housing version locked, if necessary.

Make sure that the degree of contamination specified in chapter "*Technical data*" meets the existing ambient conditions.

### 3.2 Ventilation and pressure compensation

#### Filter element - Position

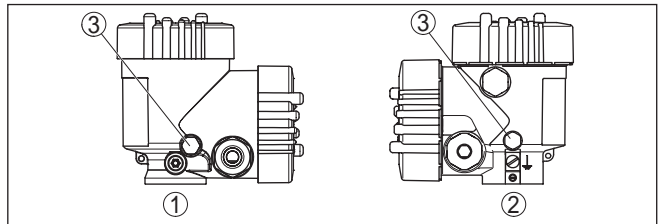

Fig. 2: Position of the filter element

- 1 Plastic double chamber housing
- 2 Aluminium, stainless steel (precision casting) double chamber
- 3 Filter element

## 4 Connecting to power supply and bus system

### 4.1 Connecting

#### Connection technology

The voltage supply and signal output are connected via the spring-loaded terminals in the housing.

Connection to the display and adjustment module or to the interface adapter is carried out via contact pins in the housing.



#### Information:

The terminal block is pluggable and can be removed from the electronics. To do this, lift the terminal block with a small screwdriver and pull it out. When reinserting the terminal block, you should hear it snap in.

#### Connection procedure

Proceed as follows:

1. Unscrew the housing lid
2. Loosen compression nut of the cable gland and remove blind plug
3. Remove approx. 10 cm (4 in) of the cable mantle (signal output), strip approx. 1 cm (0.4 in) insulation from the ends of the individual wires
4. Insert the cable into the sensor through the cable entry



Fig. 3: Connection steps 5 and 6

5. Insert the wire ends into the terminals according to the wiring plan



#### Information:

Solid cores as well as flexible cores with wire end sleeves are inserted directly into the terminal openings. In case of flexible cores without end sleeves, press the terminal from above with a small screwdriver, the terminal opening is then free. When the screwdriver is released, the terminal closes again.



6. Check the hold of the wires in the terminals by lightly pulling on them
7. Connect the cable screening to the internal ground terminal, connect the outer ground terminal to potential equalisation in case of power supply via low voltage
8. Connect the lead cable for voltage supply in the same way according to the wiring plan, in addition connect the ground conductor to the inner ground terminal when powered with mains voltage.
9. Tighten the compression nut of the cable entry gland. The seal ring must completely encircle the cable
10. Screw the housing lid back on

The electrical connection is finished.



**Information:**

The terminal blocks are pluggable and can be removed from the housing insert. To do this, lift the terminal block with a small screwdriver and pull it out. When inserting the terminal block again, you should hear it snap in.

**4.2 Wiring plan**

**Overview**

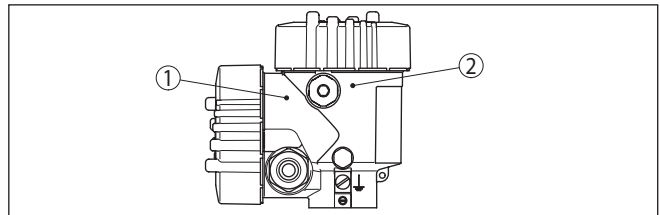

Fig. 4: Position of connection compartment (Modbus electronics) and electronics compartment (sensor electronics)

- 1 Connection compartment
- 2 Electronics compartment

**Connection compartment**

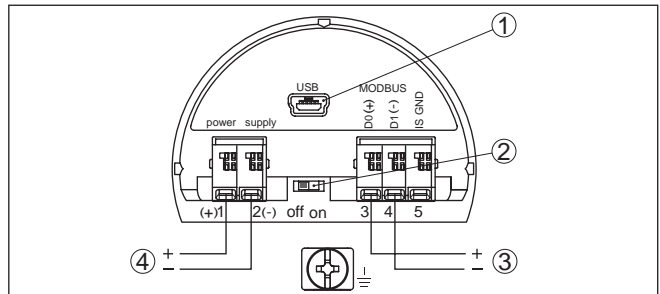

Fig. 5: Connection compartment

- 1 USB interface
- 2 Slide switch for integrated termination resistor (120 Ω)
- 3 Modbus signal
- 4 Voltage supply

Terminal	Function	Polarity
1	Voltage supply	+
2	Voltage supply	-
3	Modbus signal D0	+
4	Modbus signal D1	-
5	Function ground when installing according to CSA (Canadian Standards Association)	

## 5 Set up the sensor with the display and adjustment module

### 5.1 Insert display and adjustment module

The display and adjustment module can be inserted into the sensor and removed again at any time. You can choose any one of four different positions - each displaced by 90°. It is not necessary to interrupt the power supply.

Proceed as follows:

1. Unscrew the housing lid
2. Place the display and adjustment module on the electronics in the desired position and turn it to the right until it snaps in.
3. Screw housing lid with inspection window tightly back on

Disassembly is carried out in reverse order.

The display and adjustment module is powered by the sensor, an additional connection is not necessary.



Fig. 6: Insertion of the display and adjustment module



**Note:**

If you intend to retrofit the instrument with a display and adjustment module for continuous measured value indication, a higher lid with an inspection glass is required.

### 5.2 Parameter adjustment - Quick setup

To quickly and easily adapt the sensor to the application, select the menu item "Quick setup" in the start graphic on the display and adjustment module.



Carry out the following steps in the below sequence.

You can find "*Extended adjustment*" in the next sub-chapter.

## Presettings

### 1. Measurement loop name

In the first menu item you assign a suitable measurement loop name. Permitted are names with max. 19 characters.

### 2. Application

In this menu item, you select the application. The selection comprises process pressure and level measurement.



#### Information:

With VEGABAR 81 Modbus, the connection of a slave sensor is not possible. The item "Slave sensor" must therefore be set to "*Deactivate*".

### 3. Units

In this menu item you determine the adjustment and temperature units of the instrument. Depending on the selected application in the menu item "*Application*", different adjustment units are available.

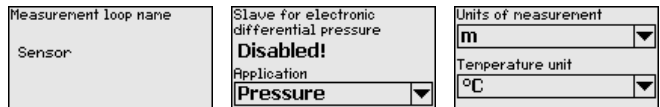

## Quick setup - Process pressure measurement

### 4. Position correction

In this menu item you compensate the influence of the installation position of the instrument (offset) on the measured value.

### 5. Zero adjustment

In this menu item you carry out the zero adjustment for the process pressure.

Enter the corresponding pressure value for 0 %.

### 6. Span adjustment

In this menu item you carry out the span adjustment for the process pressure

Enter the corresponding pressure value for 100 %.

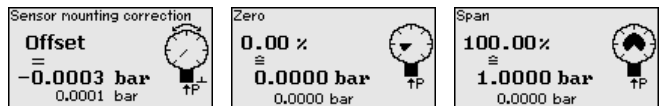

## Quick setup - Level measurement

### 4. Position correction

In this menu item you compensate the influence of the installation position of the instrument (offset) on the measured value.

### 5. Max. adjustment

In this menu item you carry out the max. adjustment for level

Enter the percentage value and the corresponding value for the max. level.

### 6. Min. adjustment

In this menu item you carry out the min. adjustment for level

Enter the percentage value and the corresponding value for the min. level.



The quick setup is finished.

**Parameterization example**

VEGABAR 81 always measures pressure independently of the process variable selected in the menu item "Application". To output the selected process variable correctly, an allocation of the output signal to 0 % and 100 % must be carried out (adjustment).

With the application "Level", the hydrostatic pressure, e.g. with full and empty vessel, is entered for adjustment. See following example:

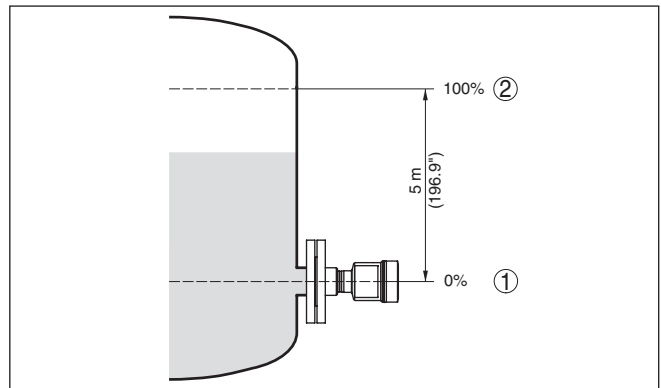

Fig. 7: Parameter adjustment example "Min./max. adjustment, level measurement"

- 1 Min. level = 0 % corresponds to 0.0 mbar
- 2 Max. level = 100 % corresponds to 490.5 mbar

If these values are not known, an adjustment with filling levels of e.g. 10 % and 90 % is also possible. By means of these settings, the real filling height is then calculated.

The real product level during the adjustment is not important, because the min./max. adjustment is always carried out without changing the product level. These settings can be made ahead of time without the instrument having to be installed.

**5.3 Parameter adjustment - Extended adjustment**

For technically demanding measuring points, you can carry out extended settings in "Extended adjustment".

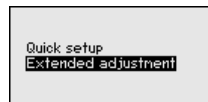

**Main menu**

The main menu is divided into five sections with the following functions:

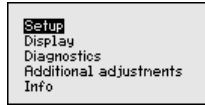

**Setup:** Settings, e.g., for measurement loop name, application, units, position correction, adjustment, signal output

**Display:** Settings, e.g., for language, measured value display, lighting

**Diagnosis:** Information, e.g. on instrument status, pointer, measurement reliability, simulation

**Additional adjustments:** PIN, date/time, reset, copy function

**Info:** Instrument name, hardware and software version, date of manufacture, sensor features

**Note:**

For optimum adjustment of the measuring point, the individual sub-menu items in the main menu item "Setup" should be selected one after the other and provided with the correct parameters. If possible, go through the items in the given sequence.

The submenu points are described below.

**5.4 Menu overview****Setup**

Menu item	Parameter	Default setting
<b>Measurement loop name</b>		Sensor
<b>Application</b>		Application level
	Slave for electronic differential pressure	Deactivated
<b>Units</b>	Unit of measurement	mbar (with nominal measuring range $\leq 400$ mbar) bar (with nominal measuring ranges $\geq 1$ bar)
	Temperature unit	°C
<b>Position correction</b>		0.00 bar
<b>Adjustment</b>	Zero/Min. adjustment	0.00 bar 0.00 %
	Span/Max. adjustment	Nominal measuring range in bar 100.00 %
<b>Damping</b>	Integration time	1.0 s
<b>Linearization</b>	Characteristics	Linear
<b>Lock adjustment</b>		Released

### Display

Menu item	Default setting
Menu language	Order-specific
Displayed value 1	Current output in %
Displayed value 2	Ceramic measuring cell: Measuring cell temperature in °C Metallic measuring cell: Electronics temperature in °C
Display format 1 and 2	Number of positions after the decimal point, automatically
Backlight	Switched on

### Diagnostics

Menu item	Parameter	Default setting
Sensor status		-
Peak value	Pressure	Actual measured value
	Temperature	Actual temperature values from measuring cell, electronics
Simulation		Pressure

### Additional adjustments

Menu item	Parameter	Default setting
PIN		0000
Date/Time		Actual date/Actual time
Reset		-
Copy instrument settings		-
Special parameters		-
Scaling	Scaling size	Volume in l
	Scaling format	0 % corresponds to 0 l 100 % corresponds to 0 l

### Info

Menu item	Parameter
Device name	Device name
Instrument version	Hardware and software version
Factory calibration date	Date
Sensor characteristics	Order-specific characteristics

## 6 Supplement

### 6.1 Technical data

#### Note for approved instruments

The technical data in the respective safety instructions are valid for approved instruments (e.g. with Ex approval). These data can differ from the data listed herein, for example regarding the process conditions or the voltage supply.

#### Electromechanical data - version IP 66/IP 67 and IP 66/IP 68 (0.2 bar)<sup>1)</sup>

Options of the cable entry

- Cable entry M20 x 1.5; ½ NPT
- Cable gland M20 x 1.5, ½ NPT (cable ø see below table)
- Blind plug M20 x 1.5; ½ NPT
- Closing cap ½ NPT

Material cable gland/Seal insert	Cable diameter			
	5 ... 9 mm	6 ... 12 mm	7 ... 12 mm	10 ... 14 mm
PA/NBR	●	●	–	●
Brass, nickel-plated/NBR	●	●	–	–
Stainless steel/NBR	–	–	●	–

Wire cross-section (spring-loaded terminals)

- Massive wire, stranded wire 0.2 ... 2.5 mm<sup>2</sup> (AWG 24 ... 14)
- Stranded wire with end sleeve 0.2 ... 1.5 mm<sup>2</sup> (AWG 24 ... 16)

#### Voltage supply

Operating voltage	8 ... 30 V DC
Power consumption	< 500 mW
Reverse voltage protection	Integrated

<sup>1)</sup> IP 66/IP 68 (0.2 bar), only with absolute pressure.



---





Printing date:

# VEGA

All statements concerning scope of delivery, application, practical use and operating conditions of the sensors and processing systems correspond to the information available at the time of printing.

Subject to change without prior notice

© VEGA Grieshaber KG, Schiltach/Germany 2019



46304-EN-190404

VEGA Grieshaber KG  
Am Hohenstein 113  
77761 Schiltach  
Germany

Phone +49 7836 50-0  
Fax +49 7836 50-201  
E-mail: [info.de@vega.com](mailto:info.de@vega.com)  
[www.vega.com](http://www.vega.com)