

# Quick setup guide

Radar sensor for continuous level measurement of liquids

## VEGAPULS 63

4 ... 20 mA/HART - four-wire



Document ID: 51881



**VEGA**

# Contents

<b>1 For your safety .....</b>	<b>3</b>
1.1 Authorised personnel .....	3
1.2 Appropriate use.....	3
1.3 Warning about incorrect use.....	3
1.4 General safety instructions .....	3
1.5 Safety label on the instrument .....	4
1.6 EU conformity.....	4
1.7 Fulfillment of NAMUR recommendations .....	4
1.8 Radio license for Europe .....	4
1.9 FCC/IC conformity (only for USA/Canada) .....	5
1.10 Environmental instructions .....	5
<b>2 Product description .....</b>	<b>6</b>
2.1 Configuration.....	6
<b>3 Mounting.....</b>	<b>7</b>
3.1 Mounting instructions .....	7
<b>4 Connecting to power supply.....</b>	<b>8</b>
4.1 Connection procedure.....	8
4.2 Wiring plan, double chamber housing .....	9
<b>5 Set up with the display and adjustment module PLICSCOM .....</b>	<b>10</b>
5.1 Insert display and adjustment module .....	10
5.2 Setup steps .....	11
5.3 Menu schematic.....	13
<b>6 Supplement .....</b>	<b>15</b>
6.1 Technical data .....	15



**Information:**

This quick setup guide enables quick setup and commissioning of your instrument.

You can find supplementary information in the corresponding, more detailed Operating Instructions Manual as well as the Safety Manual that comes with instruments with SIL qualification. These manuals are available in the download area of "[www.vega.com](http://www.vega.com)".

**Operating instructions VEGAPULS 63 - 4 ... 20 mA/HART - four-wire: Document-ID 28441**

Editing status of the quick setup guide: 2018-02-16

# 1 For your safety

## 1.1 Authorised personnel

All operations described in this operating instructions manual must be carried out only by trained specialist personnel authorised by the plant operator.

During work on and with the device the required personal protective equipment must always be worn.

## 1.2 Appropriate use

VEGAPULS 63 is a sensor for continuous level measurement.

You can find detailed information about the area of application in chapter "*Product description*".

Operational reliability is ensured only if the instrument is properly used according to the specifications in the operating instructions manual as well as possible supplementary instructions.

For safety and warranty reasons, any invasive work on the device beyond that described in the operating instructions manual may be carried out only by personnel authorised by the manufacturer. Arbitrary conversions or modifications are explicitly forbidden.

## 1.3 Warning about incorrect use

Inappropriate or incorrect use of the instrument can give rise to application-specific hazards, e.g. vessel overflow or damage to system components through incorrect mounting or adjustment. Thus damage to property, to persons or environmental contamination can be caused. Also the protective characteristics of the instrument can be influenced.

## 1.4 General safety instructions

This is a high-tech instrument requiring the strict observance of standard regulations and guidelines. The user must take note of the safety instructions in this operating instructions manual, the country-specific installation standards as well as all prevailing safety regulations and accident prevention rules. For safety reasons, only the accessory specified by the manufacturer must be used.

Depending on the model, the emitting frequencies of all radar sensors are either in the C or K band range. The low transmitting power lies far below the internationally permitted limit values. When the instrument is used correctly, it presents no danger to human health. It may be operated without restriction outside of closed metallic vessels.

The instrument must only be operated in a technically flawless and reliable condition. The operator is responsible for the trouble-free operation of the instrument. When measuring aggressive or corrosive media that can cause a dangerous situation if the instrument malfunctions, the operator has to implement suitable measures to make sure the instrument is functioning properly.

During the entire duration of use, the user is obliged to determine the compliance of the necessary occupational safety measures with the current valid rules and regulations and also take note of new regulations.

To avoid any danger, the safety approval markings and safety tips on the device must also be observed and their meaning looked up in this operating instructions manual.

### **1.5 Safety label on the instrument**

The safety approval markings and safety tips on the device must be observed.

### **1.6 EU conformity**

The device fulfils the legal requirements of the applicable EU directives. By affixing the CE marking, we confirm the conformity of the instrument with these directives.

You can find the EU conformity declaration on our website under [www.vega.com/downloads](http://www.vega.com/downloads).

#### **Electromagnetic compatibility**

The instruments are designed for use in an industrial environment. Nevertheless, electromagnetic interference from electrical conductors and radiated emissions must be taken into account, as is usual with a class A instrument according to EN 61326-1. If the instrument is used in a different environment, its electromagnetic compatibility with other devices must be ensured by suitable measures.

### **1.7 Fulfilment of NAMUR recommendations**

NAMUR is the automation technology user association in the process industry in Germany. The published NAMUR recommendations are accepted as the standard in field instrumentation.

The device fulfils the requirements of the following NAMUR recommendations:

- NE 21 – Electromagnetic compatibility of equipment
- NE 43 – Signal level for fault information from measuring transducers
- NE 53 – Compatibility of field devices and display/adjustment components

For further information see [www.namur.de](http://www.namur.de).

### **1.8 Radio license for Europe**

The instrument was tested according to the latest issue of the following harmonized standards:

- EN 302372 - Tank Level Probing Radar

It is hence approved for use inside closed vessels in countries of the EU.

Use is also approved in EFTA countries, provided the respective standards have been implemented.

For operation inside of closed vessels, points a to f in annex E of EN 302372 must be fulfilled.

### 1.9 FCC/IC conformity (only for USA/Canada)

VEGAPULS sensors with all antenna versions are FCC/IC approved.

Modifications not expressly approved by VEGA will lead to expiry of the operating licence according to FCC/IC.

VEGAPULS 63 is in conformity with part 15 of the FCC directives and fulfills the RSS-210 regulations. Note the corresponding regulations for operation:

- This device may not cause interference, and
- The device must be resistant to interference signals, including such that may cause undesired operating states of the device

According to chapter "*Dimensions*" of this operating instructions manual, the instrument is designed for operation with an antenna with a max. amplification of 33 dB. The instrument must not be operated with antennas not listed therein or those having an amplification of more than 33 dB. The required antenna impedance is 50  $\Omega$ .

### 1.10 Environmental instructions

Protection of the environment is one of our most important duties. That is why we have introduced an environment management system with the goal of continuously improving company environmental protection. The environment management system is certified according to DIN EN ISO 14001.

Please help us fulfil this obligation by observing the environmental instructions in this manual:

- Chapter "*Packaging, transport and storage*"
- Chapter "*Disposal*"

## 2 Product description

### 2.1 Configuration

#### Type label

The type label contains the most important data for identification and use of the instrument:

- Instrument type
- Article and serial number device
- Article number, documentation
- Technical data: Approvals, process seal/process temperature, signal output, voltage supply, protection, protection class
- Data matrix code for VEGA Tools app
- SIL identification (with SIL rating ex works)

#### Serial number

With the serial number, you can access the delivery data of the instrument via [www.vega.com](http://www.vega.com), "VEGA Tools" and "Instrument search". You can find the serial number on the inside of the instrument as well as on the type label on the outside.

Alternatively, you can access the data via your smartphone:

- Download the VEGA Tools app from the "Apple App Store" or the "Google Play Store"
- Scan the Data Matrix code on the type label of the instrument or
- Enter the serial number manually in the app

#### Scope of this operating instructions manual

This operating instructions manual applies to the following instrument versions:

- Hardware version  $\leq 1.1.0$
- Software version  $\leq 3.90$

### 3 Mounting

#### 3.1 Mounting instructions

##### Mounting

1. Distance from the vessel wall > 200 mm, the antenna should protrude > 10 mm into the vessel

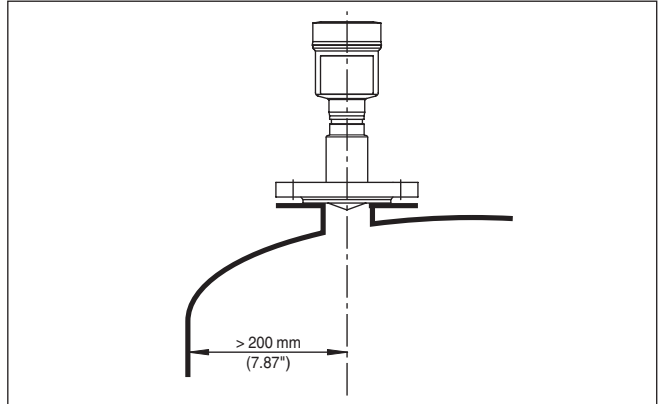

Fig. 1: Distance of the antenna to the vessel wall/vessel ceiling

2. Note min. socket diameter depending on the socket length  
For further information see chapter "Mounting".

## 4 Connecting to power supply

### 4.1 Connection procedure

Proceed as follows:

1. Unscrew the housing lid
2. If a display and adjustment module is installed, remove it by turning it to the left
3. Loosen compression nut of the cable gland and remove blind plug
4. Remove approx. 10 cm (4 in) of the cable mantle, strip approx. 1 cm (0.4 in) of insulation from the ends of the individual wires
5. Insert the cable into the sensor through the cable entry
6. Lift the opening levers of the terminals with a screwdriver (see following illustration)
7. Insert the wire ends into the open terminals according to the wiring plan

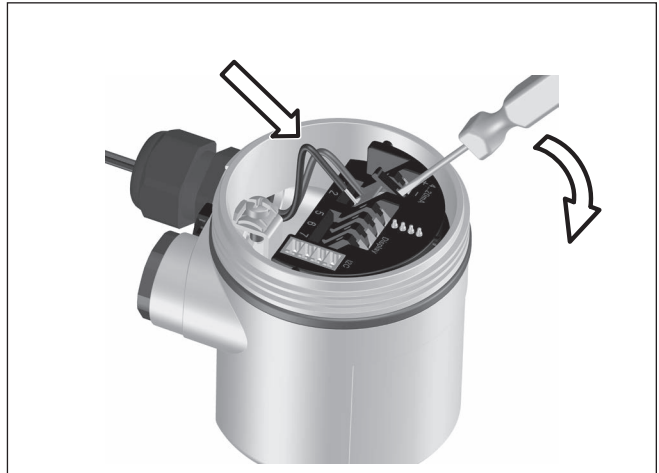

Fig. 2: Connection steps 6 and 7

8. Press down the opening levers of the terminals, you will hear the terminal spring closing
9. Check the hold of the wires in the terminals by lightly pulling on them
10. Connect the screen to the internal ground terminal, connect the external ground terminal to potential equalisation
11. Tighten the compression nut of the cable entry gland. The seal ring must completely encircle the cable
12. Screw the housing lid back on

The electrical connection is finished.



### 4.2 Wiring plan, double chamber housing



The following illustrations apply to the non-Ex as well as to the Ex-ia version.

#### Wiring plan

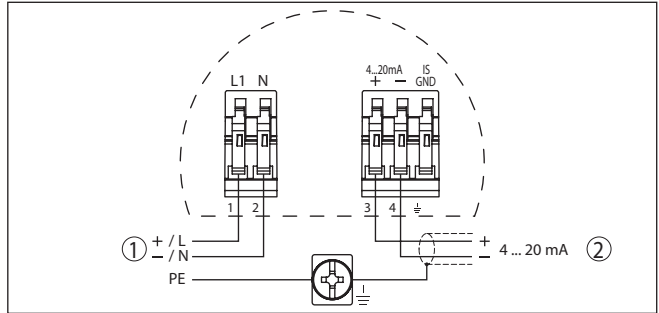

Fig. 3: Wiring plan - double chamber housing

- 1 Voltage supply
- 2 Signal output

## 5 Set up with the display and adjustment module PLICSCOM

### Mount/dismount display and adjustment module

#### 5.1 Insert display and adjustment module

The display and adjustment module can be inserted into the sensor and removed again at any time. It is not necessary to interrupt the power supply.

Proceed as follows:

1. Unscrew the housing lid
2. Place the display and adjustment module in the desired position on the electronics (you can choose any one of four different positions - each displaced by 90°)
3. Press the display and adjustment module onto the electronics and turn it to the right until it snaps in
4. Screw housing lid with inspection window tightly back on

Disassembly is carried out in reverse order.

The display and adjustment module is powered by the sensor, an additional connection is not necessary.



Fig. 4: Insert display and adjustment module



#### Note:

If you intend to retrofit the instrument with a display and adjustment module for continuous measured value indication, a higher lid with an inspection glass is required.

## 5.2 Setup steps

### Set parameters

1. Go to the menu "*Basic adjustment*" via the display and adjustment module.

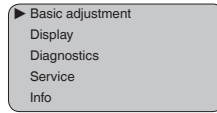

2. Carry out the adjustment in the menu items "*Min. adjustment*" and "*Max. adjustment*".

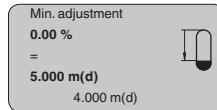
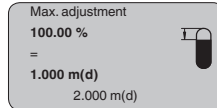

3. Select in the menu item "*Medium*" the medium of your application, for example "*Aqueous solution*".

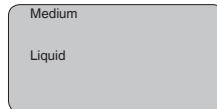

4. Select in the menu item "*Application*" the vessel, the application and the vessel form, for example, "*Storage tank*".

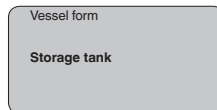

**Parameterization example** The radar sensor measures the distance from the sensor to the product surface. For indication of the real filling height, an allocation of the measured distance to the percentage height must be carried out.

The actual level is then calculated on the basis of these entered values. At the same time, the operating range of the sensor is limited from maximum range to the requested range.

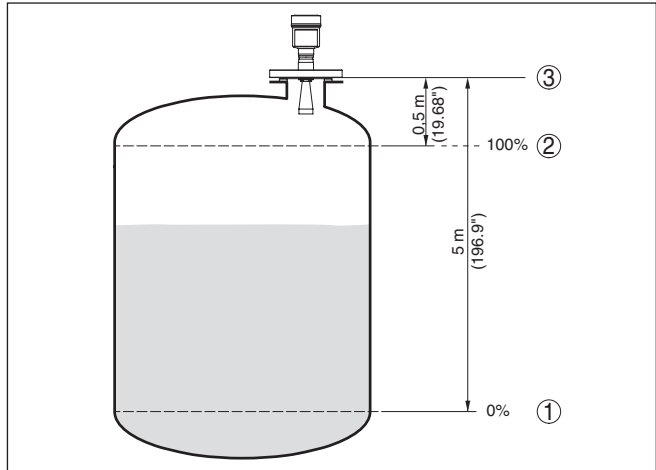

Fig. 5: Parameterisation example, Min./max. adjustment

- 1 Min. level = max. measuring distance
- 2 Max. level = min. measuring distance
- 3 Reference plane

For this adjustment, the distance is entered when the vessel is full and nearly empty. If these values are not known, an adjustment with other distances, for example, 10 % and 90 % is also possible. Starting point for these distance specifications is always the seal surface of the thread or flange.

The actual product level during this adjustment is not important, because the min./max. adjustment is always carried out without changing the product level. These settings can be made ahead of time without the instrument having to be installed.

### Service - False signal suppression

High sockets or vessel installations, such as e. g. struts or agitators as well as buildup and weld joints on the vessel walls, cause interfering reflections which can impair the measurement. A false echo storage detects and marks these false echoes, so that they are no longer taken into account for the level measurement. A false echo memory should be created with low level so that all potential interfering reflections can be detected.

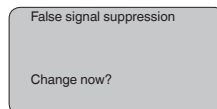

Proceed as follows:

1. Move from the measured value display to the main menu by pushing **[OK]**.
2. Select the menu item "Service" with **[->]** and confirm with **[OK]**. Now the menu item "False signal suppression" is displayed.

3. Confirm "False signal suppression - Change now" with **[OK]** and select in the below menu "Create new". Enter the actual distance from the sensor to the product surface. All false signals in this area are detected by the sensor and saved after confirming with **[OK]**.



**Note:**

Check the distance to the product surface, because if an incorrect (too large) value is entered, the existing level will be saved as a false signal. The level would then no longer be detectable in this area.

### 5.3 Menu schematic



**Information:**

Depending on the version and application, the light-coloured menu windows are not always available or offer no selection possibility.

#### Basic adjustment

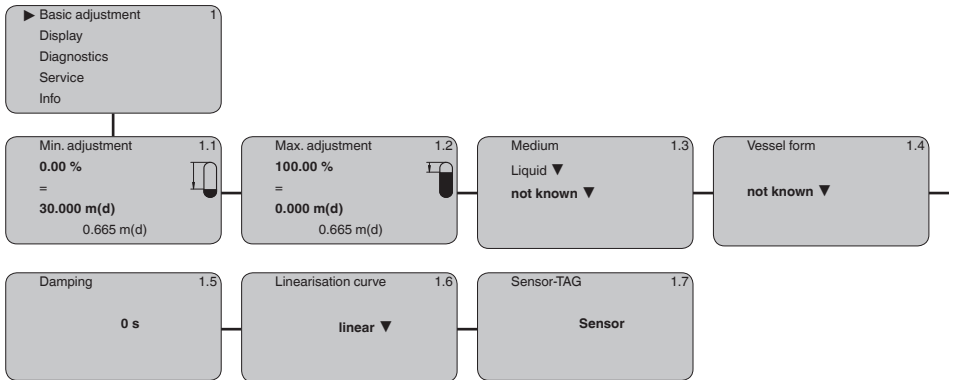

#### Display

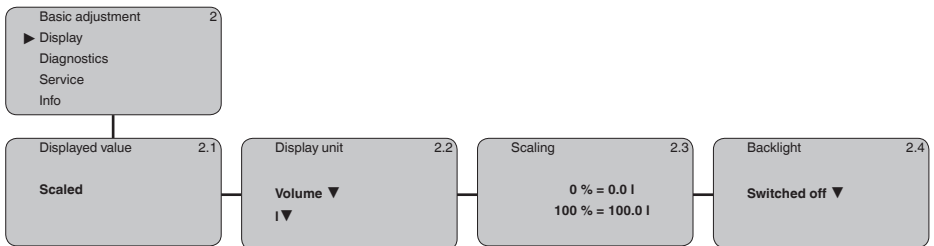

### Diagnostics

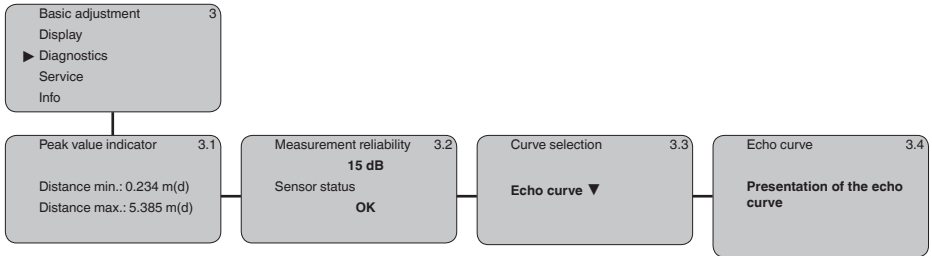

### Service



### Info

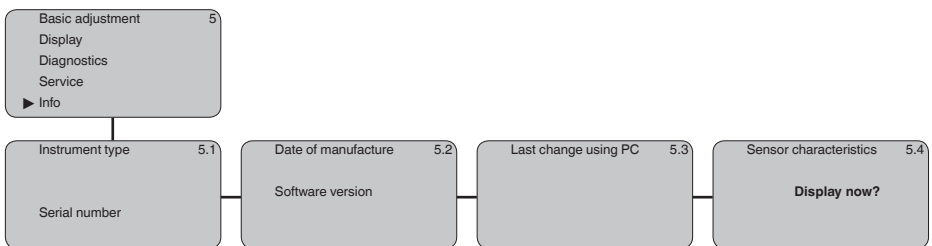

## 6 Supplement

### 6.1 Technical data

#### Note for approved instruments

The technical data in the respective safety instructions are valid for approved instruments (e.g. with Ex approval). These data can differ from the data listed herein, for example regarding the process conditions or the voltage supply.

---

#### Electromechanical data - version IP 66/IP 67

---

##### Cable entry

- |  |  |
|--|--|
| <ul style="list-style-type: none"> <li>- Double chamber housing</li> </ul> | <ul style="list-style-type: none"> <li>- 1 x cable gland M20 x 1.5 (cable: <math>\varnothing</math> 5 ... 9 mm), 1 x blind plug M20 x 1.5; plug M12 x 1 for VEGADIS 61 (optional)</li> <li>or:</li> <li>- 1 x closing cap <math>\frac{1}{2}</math> NPT, 1 x blind plug <math>\frac{1}{2}</math> NPT, plug M12 x 1 for VEGADIS 61 (optional)</li> <li>or:</li> <li>- 1 x plug (depending on the version), 1 x blind plug M20 x 1.5; plug M12 x 1 for VEGADIS 61 (optional)</li> </ul> |
|--|--|

Spring-loaded terminals for wire cross-section	< 2.5 mm <sup>2</sup> (AWG 14)
--	--------------------------------

---

#### Voltage supply

---

##### Operating voltage

- |  |   |
|--|---|
| <ul style="list-style-type: none"> <li>- Non-Ex and Ex-d instrument</li> </ul> | 20 ... 72 V DC, 20 ... 253 V AC, 50/60 Hz |
| Max. power consumption   | 4 VA; 2.1 W                               |

Printing date:

# VEGA

All statements concerning scope of delivery, application, practical use and operating conditions of the sensors and processing systems correspond to the information available at the time of printing.

Subject to change without prior notice

© VEGA Grieshaber KG, Schiltach/Germany 2018



51881-EN-180222

VEGA Grieshaber KG  
Am Hohenstein 113  
77761 Schiltach  
Germany

Phone +49 7836 50-0  
Fax +49 7836 50-201  
E-mail: [info.de@vega.com](mailto:info.de@vega.com)  
[www.vega.com](http://www.vega.com)