

Quick setup guide

Radar sensor for continuous level
measurement of bulk solids

VEGAPULS 67

Foundation Fieldbus



Document ID: 51903



VEGA

Contents

1	For your safety	3
1.1	Authorised personnel	3
1.2	Appropriate use.....	3
1.3	Warning about incorrect use.....	3
1.4	General safety instructions	3
1.5	Safety label on the instrument	4
1.6	EU conformity.....	4
1.7	Fulfillment of NAMUR recommendations	4
1.8	Radio license for Europe	4
1.9	FCC/IC conformity (only for USA/Canada)	4
1.10	Environmental instructions	5
2	Product description	6
2.1	Configuration.....	6
3	Mounting.....	7
3.1	Mounting preparation	7
3.2	Mounting instructions	9
4	Connecting to power supply.....	10
4.1	Connection procedure.....	10
4.2	Wiring plan, single chamber housing.....	11
4.3	Wiring plan, double chamber housing	11
5	Set up with the display and adjustment module PLICSCOM	12
5.1	Insert display and adjustment module	12
5.2	Setup steps	13
5.3	Menu schematic.....	15
6	Supplement	17
6.1	Technical data	17



Information:

This quick setup guide enables quick setup and commissioning of your instrument.

You can find supplementary information in the corresponding, more detailed Operating Instructions Manual as well as the Safety Manual that comes with instruments with SIL qualification. These manuals are available in the download area of "www.vega.com".

**Operating instructions VEGAPULS 67 - Foundation Fieldbus:
Document-ID 32941**

Editing status of the quick setup guide: 2018-02-16

1 For your safety

1.1 Authorised personnel

All operations described in this operating instructions manual must be carried out only by trained specialist personnel authorised by the plant operator.

During work on and with the device the required personal protective equipment must always be worn.

1.2 Appropriate use

VEGAPULS 67 is a sensor for continuous level measurement.

You can find detailed information about the area of application in chapter "*Product description*".

Operational reliability is ensured only if the instrument is properly used according to the specifications in the operating instructions manual as well as possible supplementary instructions.

For safety and warranty reasons, any invasive work on the device beyond that described in the operating instructions manual may be carried out only by personnel authorised by the manufacturer. Arbitrary conversions or modifications are explicitly forbidden.

1.3 Warning about incorrect use

Inappropriate or incorrect use of the instrument can give rise to application-specific hazards, e.g. vessel overflow or damage to system components through incorrect mounting or adjustment. Thus damage to property, to persons or environmental contamination can be caused. Also the protective characteristics of the instrument can be influenced.

1.4 General safety instructions

This is a high-tech instrument requiring the strict observance of standard regulations and guidelines. The user must take note of the safety instructions in this operating instructions manual, the country-specific installation standards as well as all prevailing safety regulations and accident prevention rules. For safety reasons, only the accessory specified by the manufacturer must be used.

Depending on the model, the emitting frequencies of all radar sensors are either in the C or K band range. The low transmitting power lies far below the internationally permitted limit values. When the instrument is used correctly, it presents no danger to human health. It may be operated without restriction outside of closed metallic vessels.

The instrument must only be operated in a technically flawless and reliable condition. The operator is responsible for the trouble-free operation of the instrument. When measuring aggressive or corrosive media that can cause a dangerous situation if the instrument malfunctions, the operator has to implement suitable measures to make sure the instrument is functioning properly.

During the entire duration of use, the user is obliged to determine the compliance of the necessary occupational safety measures with the current valid rules and regulations and also take note of new regulations.

To avoid any danger, the safety approval markings and safety tips on the device must also be observed and their meaning looked up in this operating instructions manual.

1.5 Safety label on the instrument

The safety approval markings and safety tips on the device must be observed.

1.6 EU conformity

The device fulfils the legal requirements of the applicable EU directives. By affixing the CE marking, we confirm the conformity of the instrument with these directives.

You can find the EU conformity declaration on our website under www.vega.com/downloads.

1.7 Fulfillment of NAMUR recommendations

NAMUR is the automation technology user association in the process industry in Germany. The published NAMUR recommendations are accepted as the standard in field instrumentation.

The device fulfils the requirements of the following NAMUR recommendations:

- NE 21 – Electromagnetic compatibility of equipment
- NE 43 – Signal level for fault information from measuring transducers
- NE 53 – Compatibility of field devices and display/adjustment components

For further information see www.namur.de.

1.8 Radio license for Europe

The instrument was tested according to the latest issue of the following harmonized standards:

- EN 302372 - Tank Level Probing Radar

It is hence approved for use inside closed vessels in countries of the EU.

Use is also approved in EFTA countries, provided the respective standards have been implemented.

For operation inside of closed vessels, points a to f in annex E of EN 302372 must be fulfilled.

1.9 FCC/IC conformity (only for USA/Canada)

The VEGAPULS 67 may only be used in closed vessels made of metal, concrete, or fibre-reinforced plastic.

Note about this manual:

This operating instructions manual is intended for use in a number of different countries. The illustrations show some applications of VEGAPULS 67 in atmospherically open vessels. These applications are not in conformity with the FCC/IC approvals of the instrument.

VEGAPULS 67 is FCC/IC approved with all the antenna types described in this operating instructions manual.

Conversions or modifications of the instrument not expressly approved by VEGA will lead to revocation of the operational release.

The instrument is in compliance with Part 15 of the FCC regulations. Operation is permitted only if the following two conditions are fulfilled:

1. The instrument must not emit interference radiation and
2. The instrument must operate unaffected by incoming interference radiation, also by such that may trigger unwanted operating conditions.

The instrument was tested and its compliance with the limit values for a digital Class A instrument, in conformity with Part 15 of the FCC regulations, determined. These limit values are specified to ensure a proper protection against interference radiation during operation in industrial environments. The instrument generates, uses and can emit electromagnetic waves. If the instrument is not installed and operated according to the specifications of this operating instructions manual, it can emit interference radiation that may affect communication systems. When the instrument is operated in residential areas, it is the responsibility of the operator to ensure that any interference radiation is suppressed.

1.10 Environmental instructions

Protection of the environment is one of our most important duties. That is why we have introduced an environment management system with the goal of continuously improving company environmental protection. The environment management system is certified according to DIN EN ISO 14001.

Please help us fulfil this obligation by observing the environmental instructions in this manual:

- Chapter "*Packaging, transport and storage*"
- Chapter "*Disposal*"

2 Product description

2.1 Configuration

Type label

The type label contains the most important data for identification and use of the instrument:

- Instrument type
- Article and serial number device
- Article number, documentation
- Technical data: Approvals, process seal/process temperature, signal output, voltage supply, protection, protection class
- Data matrix code for VEGA Tools app
- SIL identification (with SIL rating ex works)

Serial number

With the serial number, you can access the delivery data of the instrument via www.vega.com, "VEGA Tools" and "Instrument search". You can find the serial number on the inside of the instrument as well as on the type label on the outside.

Alternatively, you can access the data via your smartphone:

- Download the VEGA Tools app from the "Apple App Store" or the "Google Play Store"
- Scan the Data Matrix code on the type label of the instrument or
- Enter the serial number manually in the app

Scope of this operating instructions manual

This operating instructions manual applies to the following instrument versions:

- Hardware version $\leq 1.1.0$
- Software version ≤ 3.90

3 Mounting

3.1 Mounting preparation

The radar sensor can be mounted in two different ways:

- with a mounting strap
- via a collar or adapter flange.

Mounting strap

The mounting strap enables simple mounting on the vessel wall or silo top. It is suitable for wall, ceiling or boom mounting. Especially in open vessels this is a very easy and effective way to align the sensor to the bulk solid surface.

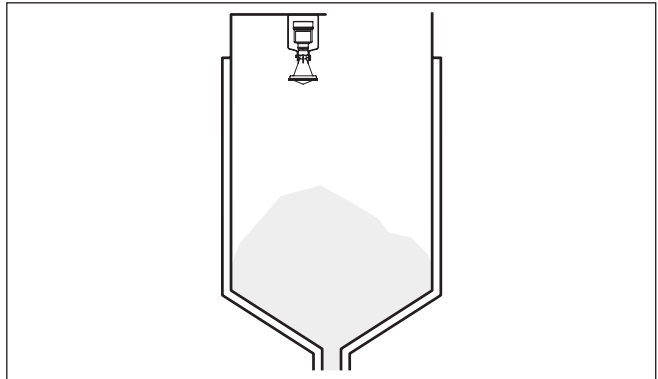

Fig. 1: Radar sensor with mounting strap

The strap is supplied unassembled and must be screwed to the sensor before setup with three hexagon socket screws M5 x 10 and spring washers. Max. torque, see chapter "Technical data". Required tools: Allen wrench size 4.

There are two ways to screw the strap onto the sensor. Depending on the selected version, the sensors can be swivelled in the strap as follows:

- Single chamber housing
 - Angle of inclination 180°, infinitely variable
 - Angle of inclination in three steps 0°, 90° and 180°
- Double chamber housing
 - Angle of inclination 90°, infinitely variable
 - Angle of inclination in two steps 0° and 90°

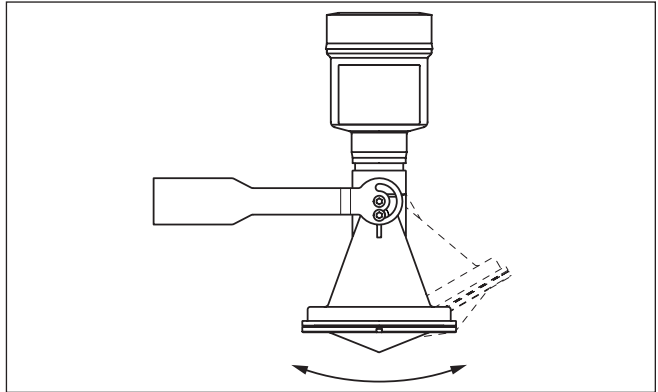

Fig. 2: Adjustment of the angle of inclination

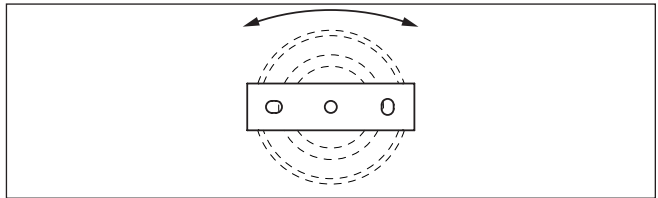

Fig. 3: Turning by fastening in the centre

Collar or adapter flange

The compression flange allows mounting on a flange DN 80/ANSI 3", the adapter flange on flanges DN 100/ANSI 4" and DN 150/ANSI 6". You can find drawings of these mounting options in chapter "Dimensions".

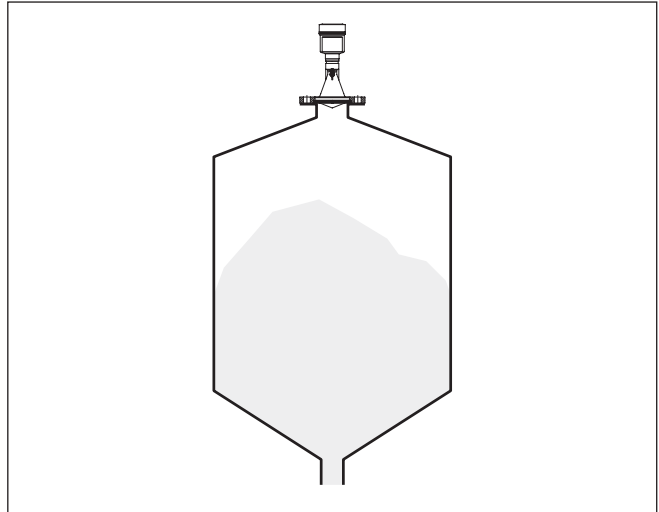

Fig. 4: Flange mounting of the radar sensor

3.2 Mounting instructions

Mounting

1. Distance from the vessel wall > 200 mm

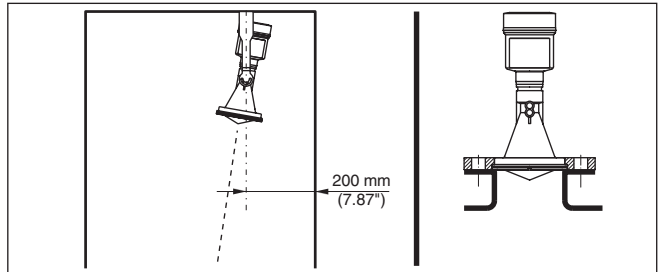

Fig. 5: Distance of the antenna to the vessel wall/socket configuration

2. Keep the socket short, round off the socket end

For further information see chapter "Mounting".

4 Connecting to power supply

4.1 Connection procedure

Proceed as follows:

1. Unscrew the housing lid
2. If a display and adjustment module is installed, remove it by turning it to the left
3. Loosen compression nut of the cable gland and remove blind plug
4. Remove approx. 10 cm (4 in) of the cable mantle, strip approx. 1 cm (0.4 in) of insulation from the ends of the individual wires
5. Insert the cable into the sensor through the cable entry
6. Lift the opening levers of the terminals with a screwdriver (see following illustration)
7. Insert the wire ends into the open terminals according to the wiring plan

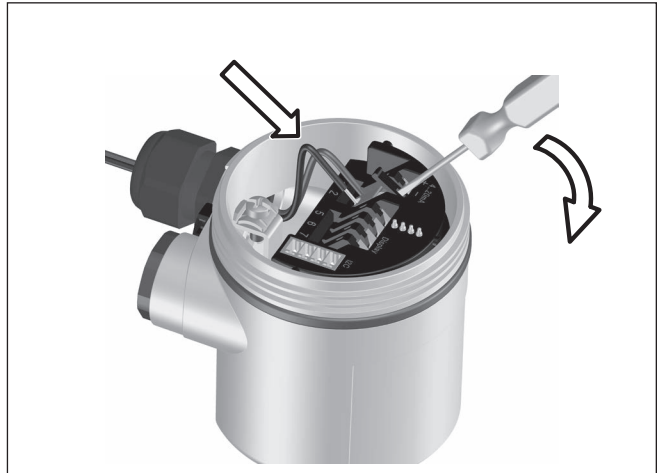

Fig. 6: Connection steps 6 and 7

8. Press down the opening levers of the terminals, you will hear the terminal spring closing
9. Check the hold of the wires in the terminals by lightly pulling on them
10. Connect the screen to the internal ground terminal, connect the external ground terminal to potential equalisation
11. Tighten the compression nut of the cable entry gland. The seal ring must completely encircle the cable
12. Screw the housing lid back on

The electrical connection is finished.

4.2 Wiring plan, single chamber housing



The following illustrations apply to the non-Ex as well as to the Ex-ia version.

Wiring plan

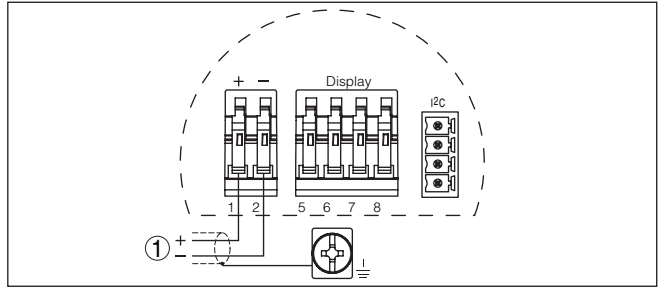

Fig. 7: Wiring plan - single chamber housing

1 Voltage supply, signal output

4.3 Wiring plan, double chamber housing



The following illustrations apply to the non-Ex as well as to the Ex-ia version.

Wiring plan

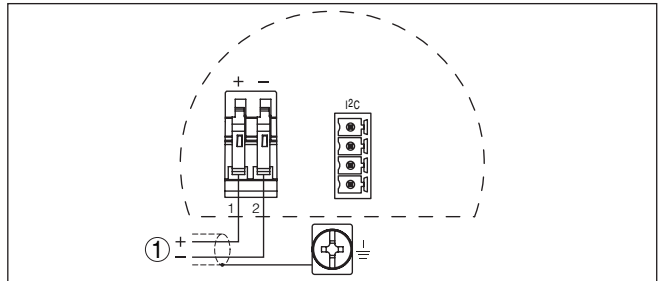

Fig. 8: Wiring plan - double chamber housing

1 Voltage supply, signal output

5 Set up with the display and adjustment module PLICSCOM

Mount/dismount display and adjustment module

5.1 Insert display and adjustment module

The display and adjustment module can be inserted into the sensor and removed again at any time. It is not necessary to interrupt the power supply.

Proceed as follows:

1. Unscrew the housing lid
2. Place the display and adjustment module in the desired position on the electronics (you can choose any one of four different positions - each displaced by 90°)
3. Press the display and adjustment module onto the electronics and turn it to the right until it snaps in
4. Screw housing lid with inspection window tightly back on

Disassembly is carried out in reverse order.

The display and adjustment module is powered by the sensor, an additional connection is not necessary.



Fig. 9: Insert display and adjustment module



Note:

If you intend to retrofit the instrument with a display and adjustment module for continuous measured value indication, a higher lid with an inspection glass is required.

5.2 Setup steps

Set parameters

1. Go to the menu "*Basic adjustment*" via the display and adjustment module.

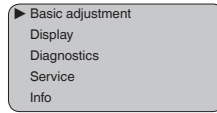

2. Carry out the adjustment in the menu items "*Min. adjustment*" and "*Max. adjustment*".

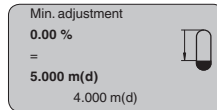
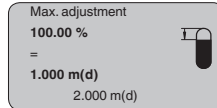

3. Select in the menu item "*Medium*" the medium of your application, for example "*Gravel/Pebble*".

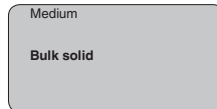

4. Select in the menu item "*Application*" the vessel and the vessel form, for example, "*Silo*".

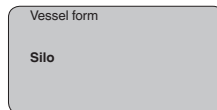

Parameterization example The radar sensor measures the distance from the sensor to the product surface. For indication of the real level, an allocation of the measured distance to the percentage height must be carried out.

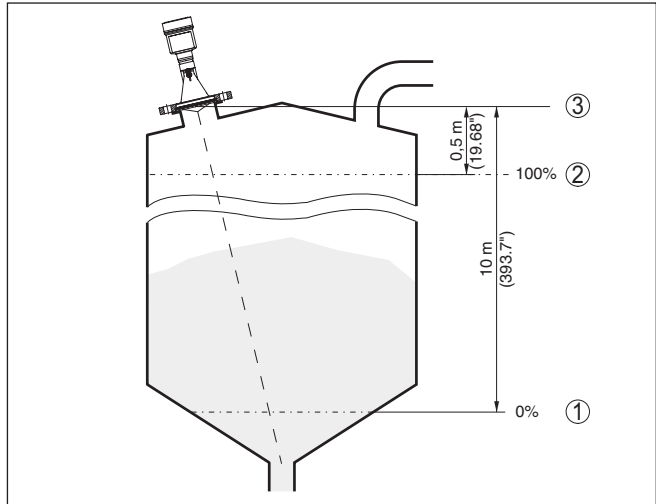

Fig. 10: Parameterization example

- 1 Min. level $\hat{=}$ max. meas. distance
- 2 Max. level $\hat{=}$ min. meas. distance
- 3 Reference plane

For this adjustment, the distance is entered when the vessel is full and nearly empty. If these values are not known, an adjustment with other distances, for example, 10 % and 90 % is also possible. Starting point for these distance specifications is always the seal surface of the thread or flange.

For this adjustment, the distance is entered when the vessel is full and nearly empty. If these values are not known, an adjustment with other distances, for example, 10 % and 90 % is also possible. Starting point for these distance specifications is always the seal surface of the thread or flange.

Service - False signal suppression

High sockets or vessel installations, such as e. g. struts or agitators as well as buildup and weld joints on the vessel walls, cause interfering reflections which can impair the measurement. A false echo storage detects and marks these false echoes, so that they are no longer taken into account for the level measurement. A false echo memory should be created with low level so that all potential interfering reflections can be detected.

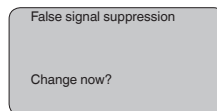

Proceed as follows:

1. Move from the measured value display to the main menu by pushing **[OK]**.

2. Select the menu item "Service" with [->] and confirm with [OK]. Now the menu item "False signal suppression" is displayed.
3. Confirm "False signal suppression - Change now" with [OK] and select in the below menu "Create new". Enter the actual distance from the sensor to the product surface. All false signals in this area are detected by the sensor and saved after confirming with [OK].



Note:

Check the distance to the product surface, because if an incorrect (too large) value is entered, the existing level will be saved as a false signal. The level would then no longer be detectable in this area.

5.3 Menu schematic



Information:

Depending on the version and application, the light-coloured menu windows are not always available or offer no selection possibility.

Basic adjustment

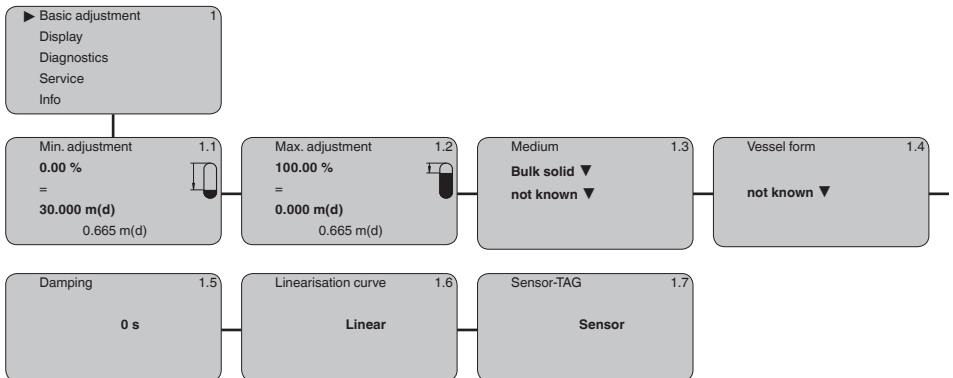

Display

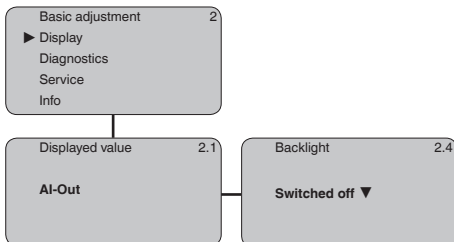

Diagnostics

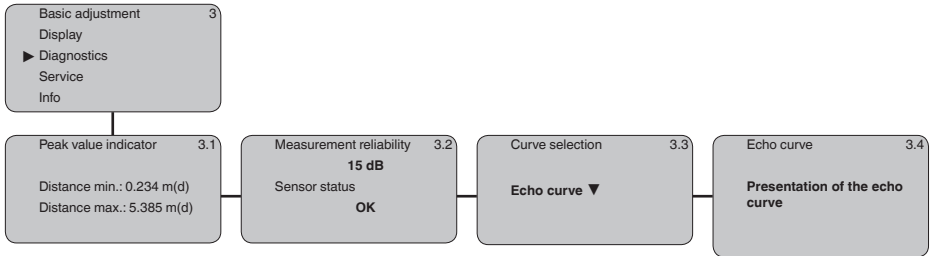

Service

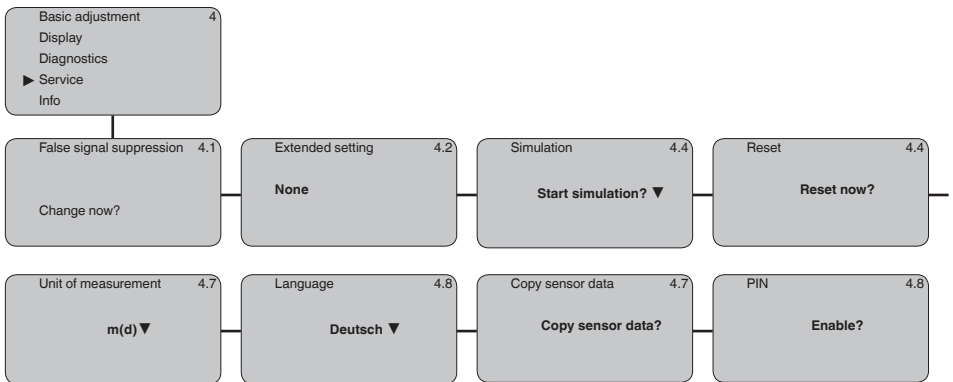

Info

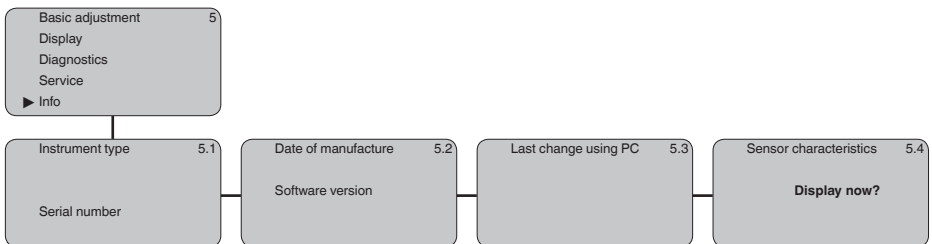

6 Supplement

6.1 Technical data

Note for approved instruments

The technical data in the respective safety instructions are valid for approved instruments (e.g. with Ex approval). These data can differ from the data listed herein, for example regarding the process conditions or the voltage supply.

Electromechanical data - version IP 66/IP 67 and IP 66/IP 68; 0.2 bar

Cable entry/plug¹⁾

- | | |
|--|---|
| <ul style="list-style-type: none"> - Single chamber housing | <ul style="list-style-type: none"> - 1 x cable gland M20 x 1.5 (cable: ø 5 ... 9 mm), 1 x blind plug M20 x 1.5 or: - 1 x closing cap M20 x 1.5; 1 x blind plug M20 x 1.5 or: - 1 x closing cap ½ NPT, 1 x blind plug ½ NPT or: - 1x plug (depending on the version), 1x blind stopper M20x1.5 |
| <ul style="list-style-type: none"> - Double chamber housing | <ul style="list-style-type: none"> - 1 x cable entry M20 x 1.5 (cable: ø 5 ... 9 mm), 1 x blind plug M20 x 1.5; 1 x blind plug M16 x 1.5 or optionally available with 1 x plug M12 x 1 for external display and adjustment unit or: - 1 x closing cap ½ NPT, 1 x blind plug ½ NPT, 1 x blind plug M16 x 1.5 or optionally 1 x plug M12 x 1 for external display and adjustment unit or: - 1 x plug (depending on the version), 1 x blind plug M20 x 1.5; 1 x blind plug M16 x 1.5 or optionally available with 1 x plug M12 x 1 for external display and adjustment unit |
| <p>Spring-loaded terminals for wire cross-section</p> | <p>< 2.5 mm² (AWG 14)</p> |

Voltage supply

Operating voltage

- | | |
|----------------------|----------------|
| - Non-Ex instrument | 9 ... 32 V DC |
| - Ex ia instrument | 9 ... 24 V DC |
| - Ex-d-ia instrument | 16 ... 32 V DC |

Operating voltage with illuminated display and adjustment module

- | | |
|----------------------|-----------------------|
| - Non-Ex instrument | 12 ... 32 V DC |
| - Ex ia instrument | 12 ... 24 V DC |
| - Ex-d-ia instrument | Lighting not possible |

¹⁾ Depending on the version M12 x 1, according to DIN 43650, Harting, 7/8" FF.

Power supply by/max. number of sensors

- Fieldbus max. 32 (max. 10 with Ex)

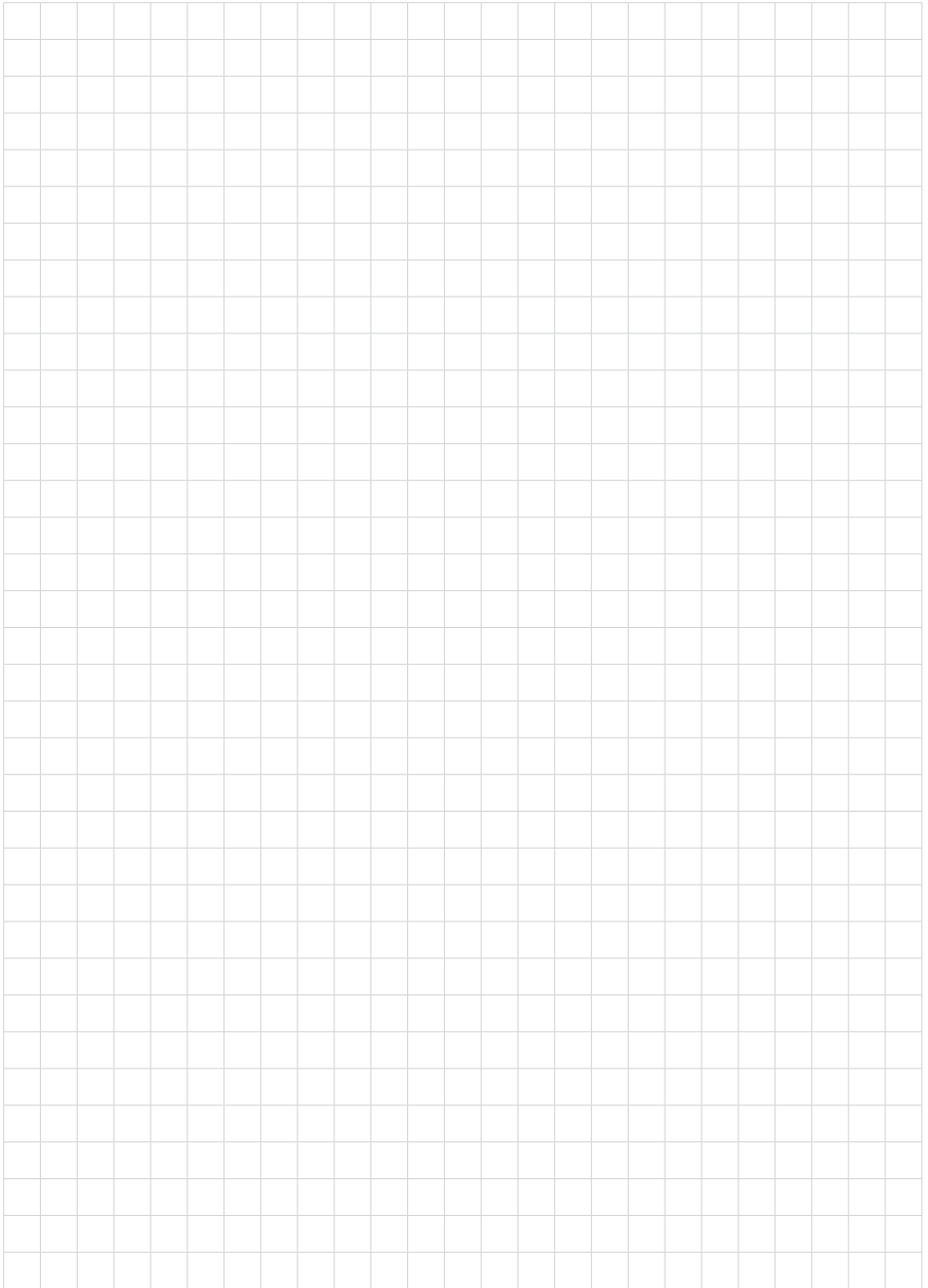

Printing date:

VEGA

All statements concerning scope of delivery, application, practical use and operating conditions of the sensors and processing systems correspond to the information available at the time of printing.

Subject to change without prior notice

© VEGA Grieshaber KG, Schiltach/Germany 2018



51903-EN-180222

VEGA Grieshaber KG
Am Hohenstein 113
77761 Schiltach
Germany

Phone +49 7836 50-0
Fax +49 7836 50-201
E-mail: info.de@vega.com
www.vega.com