

VEGAMET 842

Controller in field housing for two continuously measuring analogue level sensors



Application area

The VEGAMET 842 controller feeds the connected 4 ... 20 mA sensors, processes the measured values and displays them. A large display for data visualisation is integrated in the housing designed for rough field conditions.

It enables simple implementation of pump controls, flow measurements on open channels and weirs, totalizers, difference, sum and average value calculations. With VEGAMET 842, limit values can be reliably monitored and relays can be switched, e.g. for an overflow protection according to WHG.

Due to its various possibilities it is suitable for many industrial branches.

Your benefit

- Easy-to-read display from a distance, even in sunlight and darkness
- Complex programming of control tasks is no longer necessary
- Simple and reliable commissioning and diagnosis of the measuring points via smartphone

Function

The VEGAMET 842 controller can power the connected sensors and process their measurement signals. The requested parameter is shown on the display and also output to the integrated current output for further processing. The measurement signal can thus be transferred to a remote display or a superordinate control system. Operating relays for control of pumps or other devices are also integrated.

Approvals

Worldwide approvals are available for VEGA instruments, e.g. for use in hazardous areas, on ships or in hygienic applications.

The technical data in the respective safety instructions are valid for approved instruments (e.g. with Ex approval). In some cases, these data can differ from the data listed herein.

You can find detailed information on the existing approvals with the appropriate product on our homepage.

Technical data

Operating voltage	
– Nominal voltage AC	100 ... 230 V (-15 %, +10 %) 50/60 Hz
– Nominal voltage DC	24 ... 65 V (-15 %, +10 %)
Power consumption	max. 14 VA; 5 W

Sensor input

Number of sensors	2 x 4 ... 20 mA
Type of input (selectable)	
– Active input	Sensor supply through VEGAMET 842
– Passive input	Sensor has an own voltage supply
Measured value transmission	
– 4 ... 20 mA	analogue for 4 ... 20 mA sensors
Deviation	
– Accuracy	±20 µA (0.1 % of 20 mA)
Terminal voltage	27 ... 22 V at 4 ... 20 mA

Relay output

Quantity	3 x operating relay, one can be configured as fail safe relay
Switching voltage	max. 250 V AC/60 V DC
Switching current	max. 1 A AC (cos phi > 0.9), 1 A DC
Breaking capacity	min. 50 mW, max. 250 VA, max. 40 W DC (with U < 40 V DC)

Current output

Quantity	2 x output
Range	0/4 ... 20 mA, 20 ... 0/4 mA
Max. load	500 Ω

Bluetooth interface

Bluetooth standard	Bluetooth 5.0 (downward compatible to Bluetooth 4.0 LE)
--------------------	---

Indicators

Measured value indication	
– Graphic-capable LC display, with lighting	89 x 56 mm, digital and quasianalogue display
Adjustment elements	4 x keys for menu adjustment

Ambient conditions

Ambient temperature	
– Instrument in general	-40 ... +60 °C (-40 ... +140 °F)
– Display (readability)	-20 ... +60 °C (-4 ... +140 °F)

Electrical protective measures

Protection rating	IP66/IP67 acc. to IEC 60529, Type 4X acc. to UL 50
-------------------	--

Adjustment

The VEGAMET 842 has an integrated display and adjustment unit. In addition, the parameter adjustment of the device can be done via Bluetooth and corresponding adjustment tools.

Adjustment via the display and adjustment unit

The adjustment is carried out menu-driven via four front keys and a clearly arranged, graphic-capable display with background lighting.

Wireless adjustment via Bluetooth

The integrated Bluetooth module enables wireless connection to smartphones/tablets (iOS/Android) or Windows PCs.

Operation is via a free app from the "Apple App Store", the "Google Play Store" or the "Baidu Store". Alternatively, adjustment can also be carried out via PACTware/DTM and a Windows PC.



Wireless connection to smartphone/tablet/notebook

Electrical connection

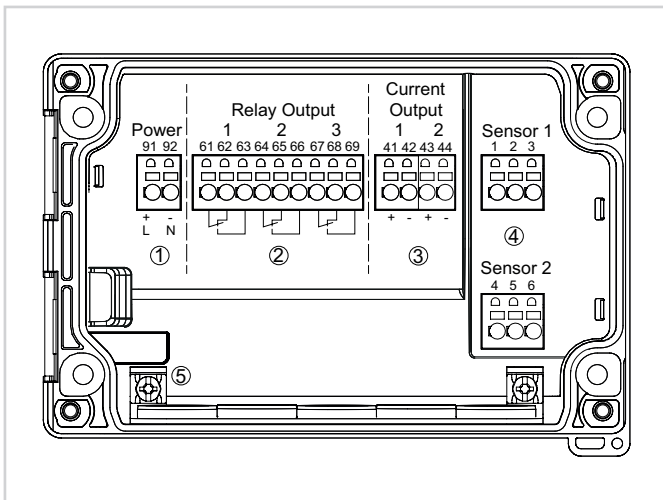

Wiring plan VEGAMET 842

- 1 Voltage supply of the controller
- 2 Relay outputs 1 ... 3
- 3 Current outputs 1/2
- 4 Sensor inputs 1/2 (active/passive)
- 5 Ground terminal for protective conductor

Details on the electrical connection can be found in the operating instructions of the device in the download area on our homepage.

Dimensions

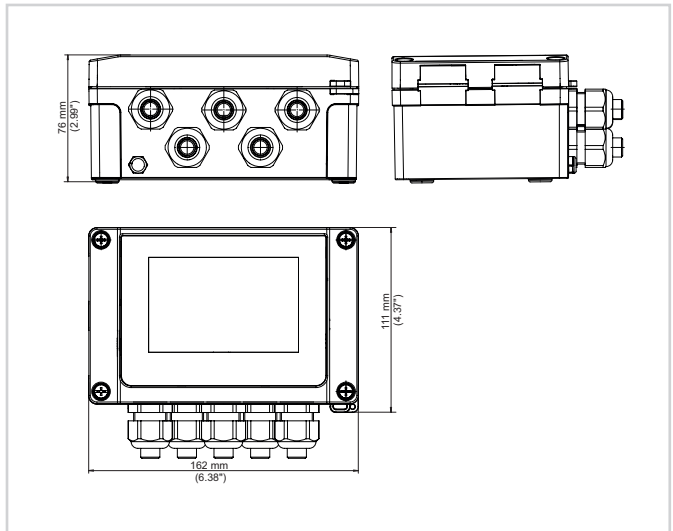

Information

You can find further information on the VEGA product line on our homepage.

In the download section on our homepage you'll find operating instructions, product information, brochures, approval documents, instrument drawings and much, much more.

Software accessories such as the current device software and the appropriate operating software are also available there.

Contact

You can find your personal contact person at VEGA on our homepage under "Contact".