

Operating Instructions

Overvoltage arrester

B 62-30 W

For Profibus PA and Foundation Fieldbus circuits



Document ID: 40492



VEGA

Contents

- 1 About this document**
 - 1.1 Function 3
 - 1.2 Target group 3
 - 1.3 Symbols used..... 3
- 2 For your safety**
 - 2.1 Authorised personnel 4
 - 2.2 Appropriate use..... 4
 - 2.3 Warning about incorrect use..... 4
 - 2.4 General safety instructions 4
 - 2.5 Safety label on the instrument 5
 - 2.6 EU conformity..... 5
 - 2.7 Environmental instructions 5
- 3 Product description**
 - 3.1 Configuration..... 6
 - 3.2 Principle of operation..... 6
 - 3.3 Packaging, transport and storage..... 7
- 4 Mounting instructions**
 - 4.1 Installation in switching cabinet 9
 - 4.2 Mounting in housing 10
- 5 Connecting to power supply**
 - 5.1 Preparing the connection 12
 - 5.2 Connection steps for version with housing 12
 - 5.3 Wiring plan 12
- 6 Maintenance and fault rectification**
 - 6.1 Maintenance 14
 - 6.2 Rectify faults..... 14
 - 6.3 How to proceed if a repair is necessary..... 14
- 7 Dismount**
 - 7.1 Dismounting steps..... 15
 - 7.2 Disposal 15
- 8 Supplement**
 - 8.1 Technical data 16
 - 8.2 Dimensions B62-30W 17

Safety instructions for Ex areas



Take note of the Ex specific safety instructions for Ex applications. These instructions are attached as documents to each instrument with Ex approval and are part of the operating instructions manual.

Editing status: 2017-04-28

1 About this document

1.1 Function

This operating instructions manual provides all the information you need for mounting, connection and setup of the instrument. Furthermore there are important instructions for maintenance, fault rectification, the exchange of parts and the safety of the user. Please read this information before putting the instrument into operation and keep this manual accessible in the immediate vicinity of the device.

1.2 Target group

This operating instructions manual is directed to trained specialist personnel. The contents of this manual should be made available to these personnel and put into practice by them.

1.3 Symbols used



Information, tip, note

This symbol indicates helpful additional information.



Caution: If this warning is ignored, faults or malfunctions can result.



Warning: If this warning is ignored, injury to persons and/or serious damage to the instrument can result.



Danger: If this warning is ignored, serious injury to persons and/or destruction of the instrument can result.



Ex applications

This symbol indicates special instructions for Ex applications.



SIL applications

This symbol indicates instructions for functional safety which must be taken into account particularly for safety-relevant applications.

- **List**

The dot set in front indicates a list with no implied sequence.

- **Action**

This arrow indicates a single action.

- 1 **Sequence of actions**

Numbers set in front indicate successive steps in a procedure.



Battery disposal

This symbol indicates special information about the disposal of batteries and accumulators.

2 For your safety

2.1 Authorised personnel

All operations described in this operating instructions manual must be carried out only by trained specialist personnel authorised by the plant operator.

During work on and with the device the required personal protective equipment must always be worn.

2.2 Appropriate use

The B62-30W is an overvoltage arrester for supply and control cables for Profibus PA instruments.

You can find detailed information about the area of application in chapter "*Product description*".

2.3 Warning about incorrect use

Inappropriate or incorrect use of the instrument can give rise to application-specific hazards, e.g. vessel overfill or damage to system components through incorrect mounting or adjustment. Thus damage to property, to persons or environmental contamination can be caused. Also the protective characteristics of the instrument can be influenced.

2.4 General safety instructions

This is a state-of-the-art instrument complying with all prevailing regulations and directives. The instrument must only be operated in a technically flawless and reliable condition. The operator is responsible for the trouble-free operation of the instrument. When measuring aggressive or corrosive media where a malfunction of the instrument can cause a danger, the operator has to convince himself on the correct function of the instrument by taking suitable measures.

During the entire duration of use, the user is obliged to determine the compliance of the necessary occupational safety measures with the current valid rules and regulations and also take note of new regulations.

The safety instructions in this operating instructions manual, the national installation standards as well as the valid safety regulations and accident prevention rules must be observed by the user.

For safety and warranty reasons, any invasive work on the device beyond that described in the operating instructions manual may be carried out only by personnel authorised by the manufacturer. Arbitrary conversions or modifications are explicitly forbidden. For safety reasons, only the accessory specified by the manufacturer must be used.

To avoid any danger, the safety approval markings and safety tips on the device must also be observed and their meaning looked up in this operating instructions manual.

2.5 Safety label on the instrument

The safety approval markings and safety tips on the device must be observed.

2.6 EU conformity

The device fulfils the legal requirements of the applicable EU directives. By affixing the CE marking, we confirm successful testing of the product.

You can find the CE Certificate of Conformity in the download section under "www.vega.com".

2.7 Environmental instructions

Protection of the environment is one of our most important duties. That is why we have introduced an environment management system with the goal of continuously improving company environmental protection. The environment management system is certified according to DIN EN ISO 14001.

Please help us fulfil this obligation by observing the environmental instructions in this manual:

- Chapter "*Packaging, transport and storage*"
- Chapter "*Disposal*"

3 Product description

3.1 Configuration

Scope of delivery

The scope of delivery encompasses:

- Overvoltage arrester B62-30W
- Documentation
 - This operating instructions manual
 - Ex specific safety instructions and, if necessary, further certificates

Constituent parts

The following illustration shows the configuration of the overvoltage arrester B62-30W:

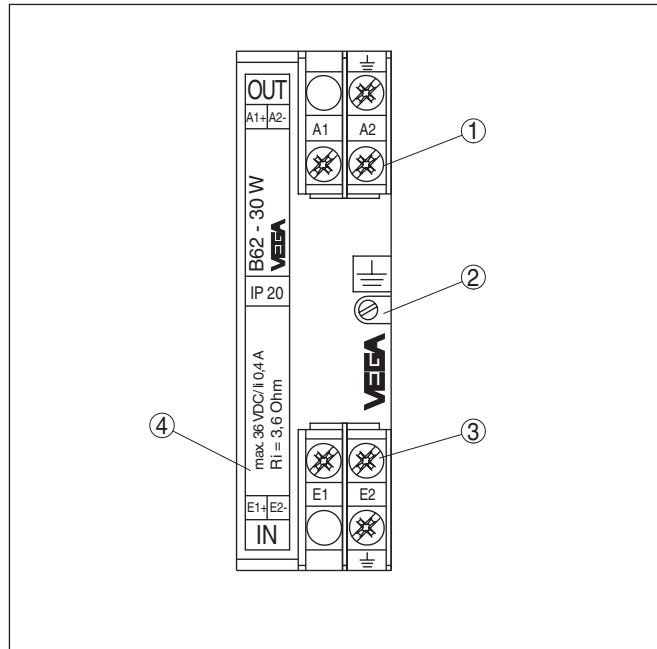

Fig. 1: Configuration of B62-30W

- 1 Terminals Out (protected side)
- 2 Screw for carrier rail fastening
- 3 Terminals In (unprotected side)
- 4 Type label

3.2 Principle of operation

Application area

Voltage surges can be caused by indirect atmospheric discharges (lightning strokes) or switching operations in the supply network. Further causes can be inductive or capacitive couplings from other electrical systems. Voltage peaks (transients) must be expected especially when long power supply and signal cables are used.

Such voltage surges can cause damage to sensors and signal conditioning instruments.

VEGA overvoltage arresters reduce voltage surges on the supply or signal cables to a safe level. They are designed for mounting on carrier rail according to EN 50 022/EN 50 035 in the switching cabinet or in a metal or plastic housing close to the sensor.

Functional principle

Depending on the version, different combinations of protective elements for voltage limitation are used. Typical protective elements are suppressor diodes (diodes with special characteristics), varistors (voltage-dependent resistors) as well as overvoltage arresters (gas arresters).

As soon as the voltage increases to the response voltage of the protective element, the element becomes conductive and the energy is discharged to ground. After the overvoltage has subsided, the protective element returns to its high-impedance state and thus has no influence on the supply or signal circuit.

3.3 Packaging, transport and storage

Packaging

Your instrument was protected by packaging during transport. Its capacity to handle normal loads during transport is assured by a test based on ISO 4180.

The packaging of standard instruments consists of environment-friendly, recyclable cardboard. For special versions, PE foam or PE foil is also used. Dispose of the packaging material via specialised recycling companies.

Transport

Transport must be carried out in due consideration of the notes on the transport packaging. Nonobservance of these instructions can cause damage to the device.

Transport inspection

The delivery must be checked for completeness and possible transit damage immediately at receipt. Ascertained transit damage or concealed defects must be appropriately dealt with.

Storage

Up to the time of installation, the packages must be left closed and stored according to the orientation and storage markings on the outside.

Unless otherwise indicated, the packages must be stored only under the following conditions:

- Not in the open
- Dry and dust free
- Not exposed to corrosive media
- Protected against solar radiation
- Avoiding mechanical shock and vibration

Storage and transport temperature

- Storage and transport temperature see chapter "*Supplement - Technical data - Ambient conditions*"
- Relative humidity 20 ... 85 %

Lifting and carrying

With an instrument weight of more than 18 kg (39.68 lbs) suitable and approved equipment must be used for lifting and carrying.

4 Mounting instructions

4.1 Installation in switching cabinet

The overvoltage arrester is mounted in the switching cabinet on carrier rails according to EN 50 022 (DIN rail) or EN 50 035 (C-rail). It is fastened to the carrier rail with a screw located on its exterior. The screw is marked with the symbol for functional ground. Depending on the version, it may be galvanically connected to the ground terminal of the overvoltage arrester (see circuit diagram in chapter "Wiring plan").

The carrier rail must be connected (low impedance) to the potential equalization line (PA). The wire cross-section must be at least 2.5 mm², the cable must be as short as possible.

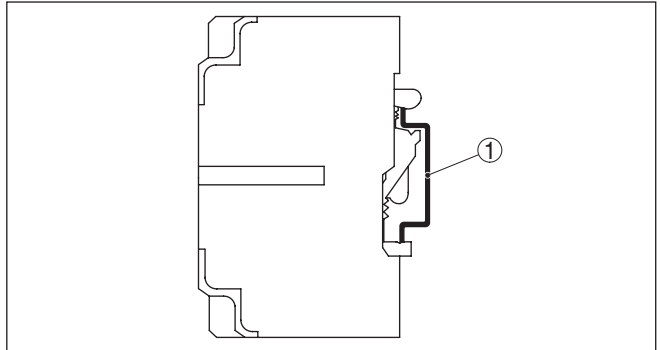

Fig. 2: Mounting on carrier rail according to EN 50 022 (DIN rail) 35 x 7.5 mm

1 Carrier rail

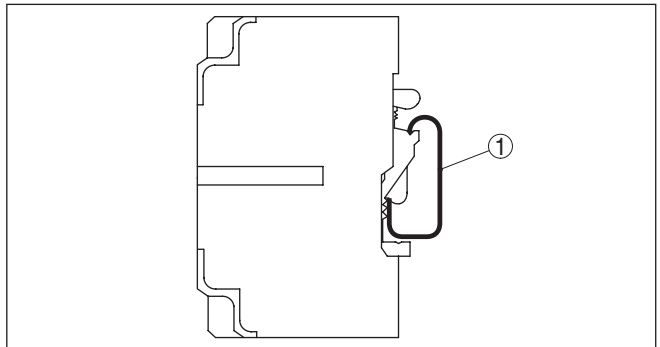

Fig. 3: Mounting on carrier rail according to EN 50 035 (C-rail) 35 x 7.5 mm

1 Carrier rail

Installation procedure

Proceed as follows:

1. Loosen fixing screw

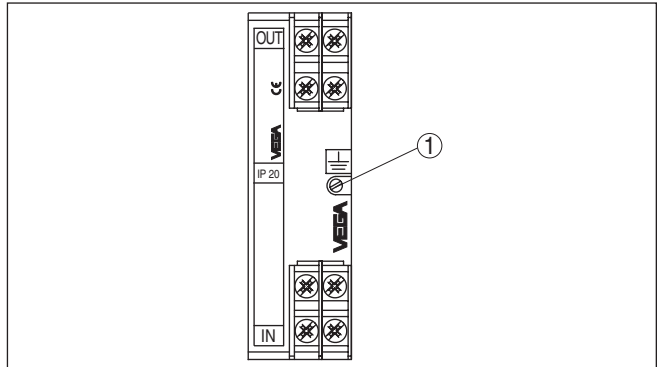

Fig. 4: Mounting on carrier rail

- 1 Fixing screw
2. Place the overvoltage arrester onto the rail and let it snap in
3. Tighten fixing screw

4.2 Mounting in housing

The overvoltage arrester is optionally available in a plastic or aluminium housing. Make sure when mounting that the cable glands point downward. Thus avoids water ingress.

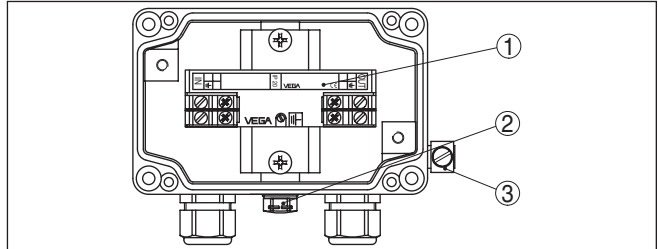

Fig. 5: Mounting in Aluminium housing

- 1 Overvoltage arrester
- 2 Pressure compensation
- 3 Ground terminal

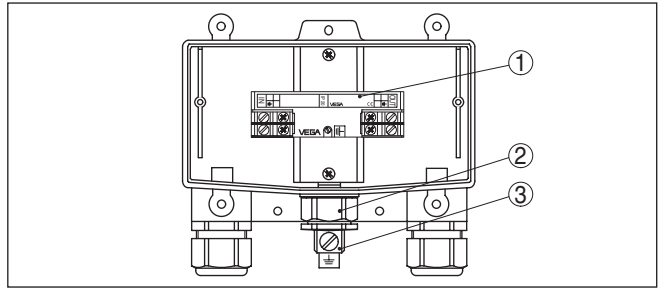

Fig. 6: Mounting in plastic housing

- 1 Overvoltage arrester
- 2 Pressure compensation
- 3 Ground terminal

The carrier rail inside the housing is galvanically connected to the ground terminal outside on the housing. This ground terminal must be connected (low impedance) with the potential equalization line (PA). The wire cross-section must be at least 2.5 mm², the cable must be as short as possible.

5 Connecting to power supply

5.1 Preparing the connection

Note safety instructions

Always keep in mind the following safety instructions:

- Connect only in the complete absence of line voltage

Before starting setup make sure that the power supply corresponds to the specifications on the type label.

For effective overvoltage protection, the cables between overvoltage arrester and instrument should be as short as possible.

5.2 Connection steps for version with housing

Proceed as follows:

1. Loosen screws of the housing cover
2. Push the supply and connection cables through the cable gland into the housing, strip approx. 1 cm (0.4 in) insulation from the ends of the wires
3. Connect the wire ends according to chapter "Wiring plan" to the terminals of the overvoltage arrester
4. Connect the outer ground terminal on the housing to potential equalization
5. Check all cable connections, especially the ground connection, to make sure they are tightened sufficiently
6. Tighten the compression nuts of the cable glands. The seal ring must completely encircle the cable
7. Tighten screws of the housing cover

The electrical connection is finished.

5.3 Wiring plan

Circuit diagram

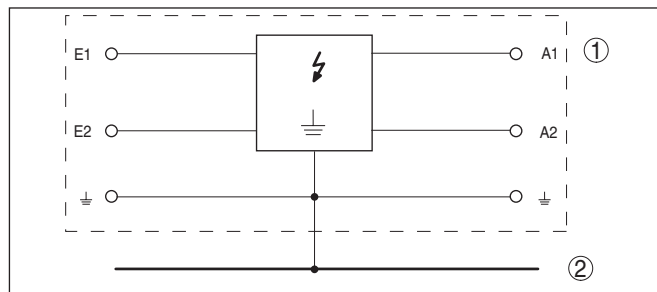

Fig. 7: Circuit diagram B62-30W

- 1 Circuit diagram overvoltage arrester B62-30W
- 2 Potential equalisation

Wiring plan - Sensor protection

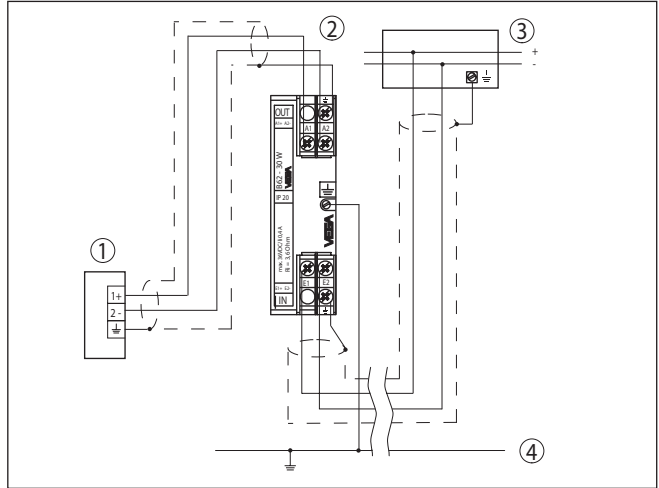

Fig. 8: Wiring plan B62-30W - Sensor protection

- 1 Sensor
- 2 Overvoltage arrester for sensor
- 3 Profibus PA System
- 4 Potential equalisation

Wiring plan - Protection for bus system

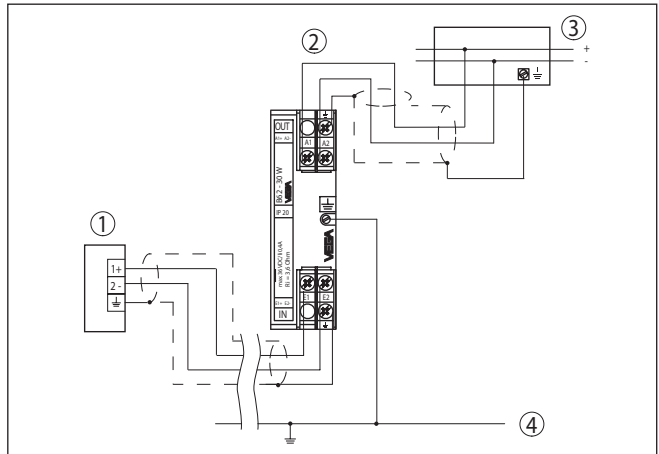

Fig. 9: Wiring plan B62-30W - Protection for bus system

- 1 Sensor
- 2 Overvoltage arrester for bus system
- 3 Profibus PA System
- 4 Potential equalisation

6 Maintenance and fault rectification

6.1 Maintenance

If the device is used properly, no special maintenance is required in normal operation.

6.2 Rectify faults

Reaction when malfunction occurs

The operator of the system is responsible for taking suitable measures to rectify faults.

Fault rectification

The first measure to be taken is to check the input/output signal as well as the power supply. In many cases, the causes can be determined and faults can be quickly rectified.

On-site repair of B62-30W is not possible.

24 hour service hotline

Should these measures not be successful, please call in urgent cases the VEGA service hotline under the phone no. **+49 1805 858550**.

The hotline is manned 7 days a week round-the-clock. Since we offer this service worldwide, the support is only available in the English language. The service is free, only standard call charges are incurred.

Reaction after fault rectification

Depending on the reason for the fault and the measures taken, the steps described in chapter "Set up" may have to be carried out again.

6.3 How to proceed if a repair is necessary

You can find an instrument return form as well as detailed information about the procedure in the download area of our homepage: www.vega.com.

By doing this you help us carry out the repair quickly and without having to call back for needed information.

If a repair is necessary, please proceed as follows:

- Print and fill out one form per instrument
- Clean the instrument and pack it damage-proof
- Attach the completed form and, if need be, also a safety data sheet outside on the packaging
- Please contact the agency serving you to get the address for the return shipment. You can find the agency on our home page www.vega.com.

7 Dismount

7.1 Dismounting steps

Take note of chapters "*Mounting*" and "*Connecting to power supply*" and carry out the listed steps in reverse order.

7.2 Disposal

The instrument consists of materials which can be recycled by specialised recycling companies. We use recyclable materials and have designed the electronics to be easily separable.

WEEE directive 2002/96/EG

This instrument is not subject to the WEEE directive 2002/96/EG and the respective national laws. Pass the instrument directly on to a specialised recycling company and do not use the municipal collecting points. These may be used only for privately used products according to the WEEE directive.

Correct disposal avoids negative effects on humans and the environment and ensures recycling of useful raw materials.

Materials: see chapter "*Technical data*"

If you have no way to dispose of the old instrument properly, please contact us concerning return and disposal.

8 Supplement

8.1 Technical data

Note for approved instruments

The technical data in the respective safety instructions are valid for approved instruments (e.g. with Ex approval). These data can differ from the data listed herein, for example regarding the process conditions or the voltage supply.

General data

Version	Device for carrier rail mounting
Housing material	Plastic (PPE)
Weight approx.	175 g (0.385 lbs)

Electrical characteristics¹⁾

Operating voltage	9 ... 36 V DC
Max. permissible current per circuit	0.6 A
R_i per circuit	$\leq 3.6 \Omega$
L_i per circuit	0 mH
C_i per circuit	0 nF
Response voltage	41 V DC
Response time	$< 10^{-11}$ s
Discharge current	< 10 kA (8/20 μ s)

Electromechanical data

Screw terminals for cable cross-section	$< 2.5 \text{ mm}^2$ (AWG 14)
---	-------------------------------

Ambient conditions

Ambient temperature	-40 ... +60 °C (-40 ... +140 °F)
Storage and transport temperature	-40 ... +70 °C (-40 ... +158 °F)

Electrical protective measures

Protection rating	
– unassembled	IP 20
– In Aluminium or plastic housing	IP 65

¹⁾ Reference temperature 25 °C (77 °F).

8.2 Dimensions B62-30W

Overvoltage arrester

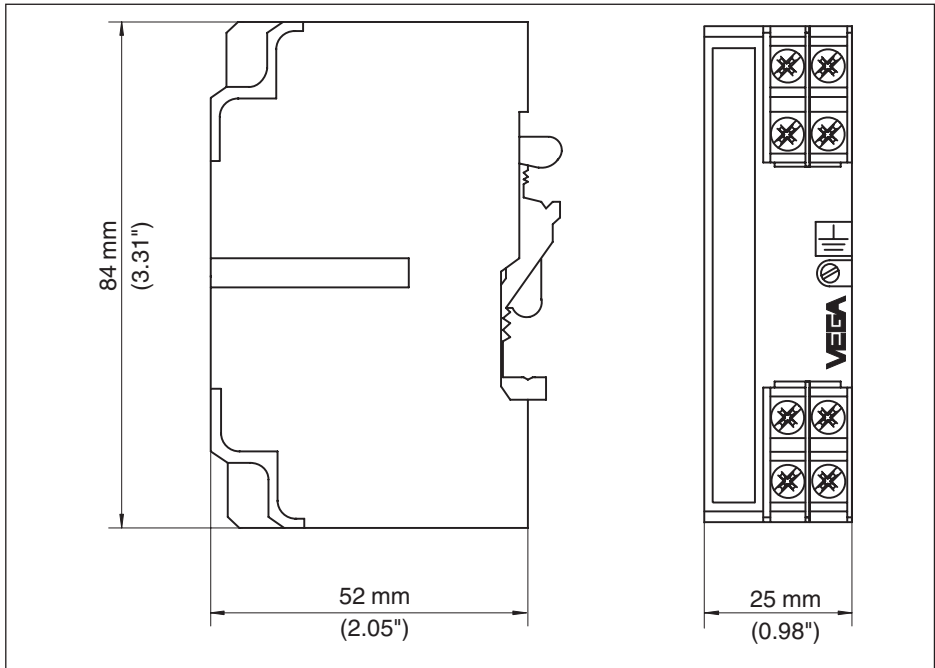

Fig. 10: Dimensions B62-30W

Housing

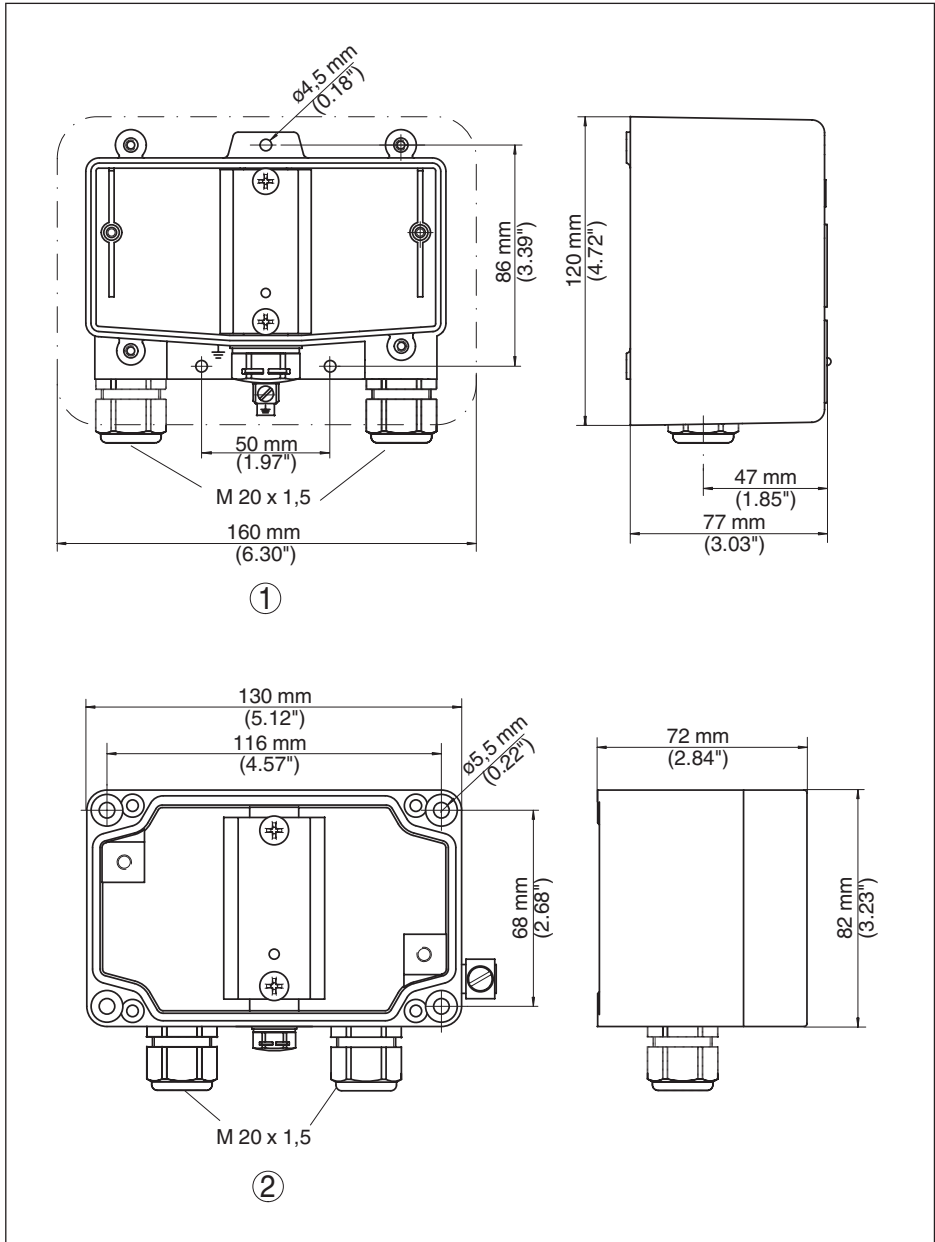

Fig. 11: Dimensions B62-30W

- 1 Plastic housing
- 2 Aluminium housing



Printing date:

VEGA

All statements concerning scope of delivery, application, practical use and operating conditions of the sensors and processing systems correspond to the information available at the time of printing.

Subject to change without prior notice

© VEGA Grieshaber KG, Schiltach/Germany 2017



40492-EN-170510

VEGA Grieshaber KG
Am Hohenstein 113
77761 Schiltach
Germany

Phone +49 7836 50-0
Fax +49 7836 50-201
E-mail: info.de@vega.com
www.vega.com