

# Quick setup guide

Radar sensor for continuous level measurement of liquids

## VEGAPULS 63

4 ... 20 mA/HART - four-wire



Document ID: 47127



**VEGA**

# Contents

<b>1 For your safety .....</b>	<b>3</b>
1.1 Authorised personnel .....	3
1.2 Appropriate use.....	3
1.3 Warning about incorrect use.....	3
1.4 General safety instructions .....	3
1.5 EU conformity.....	4
1.6 NAMUR recommendations .....	4
1.7 Radio license for Europe .....	4
1.8 Radio license for USA .....	5
1.9 Environmental instructions .....	5
<b>2 Product description .....</b>	<b>6</b>
2.1 Configuration.....	6
<b>3 Mounting .....</b>	<b>8</b>
3.1 Mounting instructions .....	8
<b>4 Connecting to power supply.....</b>	<b>9</b>
4.1 Connecting.....	9
4.2 Wiring plan, double chamber housing .....	10
<b>5 Set up with the display and adjustment module .....</b>	<b>12</b>
5.1 Insert display and adjustment module .....	12
5.2 Parameter adjustment .....	12
5.3 Menu overview .....	15
<b>6 Supplement .....</b>	<b>17</b>
6.1 Technical data .....	17



**Information:**

This quick setup guide enables quick setup and commissioning of your instrument.

You can find supplementary information in the corresponding, more detailed Operating Instructions Manual as well as the Safety Manual that comes with instruments with SIL qualification. These manuals are available in the download area of "[www.vega.com](http://www.vega.com)".

**Operating instructions VEGAPULS 63 - 4 ... 20 mA/HART - four-wire: Document-ID 36512**

Editing status of the quick setup guide: 2018-07-05

# 1 For your safety

## 1.1 Authorised personnel

All operations described in this documentation must be carried out only by trained specialist personnel authorised by the plant operator. During work on and with the device the required personal protective equipment must always be worn.

## 1.2 Appropriate use

VEGAPULS 63 is a sensor for continuous level measurement.

You can find detailed information about the area of application in chapter "*Product description*".

Operational reliability is ensured only if the instrument is properly used according to the specifications in the operating instructions manual as well as possible supplementary instructions.

## 1.3 Warning about incorrect use

Inappropriate or incorrect use of this product can give rise to application-specific hazards, e.g. vessel overflow through incorrect mounting or adjustment. Damage to property and persons or environmental contamination can result. Also, the protective characteristics of the instrument can be impaired.

## 1.4 General safety instructions

This is a state-of-the-art instrument complying with all prevailing regulations and directives. The instrument must only be operated in a technically flawless and reliable condition. The operator is responsible for the trouble-free operation of the instrument. When measuring aggressive or corrosive media that can cause a dangerous situation if the instrument malfunctions, the operator has to implement suitable measures to make sure the instrument is functioning properly.

During the entire duration of use, the user is obliged to determine the compliance of the necessary occupational safety measures with the current valid rules and regulations and also take note of new regulations.

The safety instructions in this operating instructions manual, the national installation standards as well as the valid safety regulations and accident prevention rules must be observed by the user.

For safety and warranty reasons, any invasive work on the device beyond that described in the operating instructions manual may be carried out only by personnel authorised by the manufacturer. Arbitrary conversions or modifications are explicitly forbidden. For safety reasons, only the accessory specified by the manufacturer must be used.

To avoid any danger, the safety approval markings and safety tips on the device must also be observed and their meaning read in this operating instructions manual.

Depending on the instrument version, the emitting frequencies are in the C, K or W band range. The low emission power is far below the internationally approved limit values. When used correctly, the device poses no danger to health.

## 1.5 EU conformity

The device fulfils the legal requirements of the applicable EU directives. By affixing the CE marking, we confirm the conformity of the instrument with these directives.

You can find the EU conformity declaration on our website under [www.vega.com/downloads](http://www.vega.com/downloads).

### Electromagnetic compatibility

Instruments in four-wire or Ex-d-ia version are designed for use in an industrial environment. Nevertheless, electromagnetic interference from electrical conductors and radiated emissions must be taken into account, as is usual with class A instruments according to EN 61326-1. If the instrument is used in a different environment, the electromagnetic compatibility to other instruments must be ensured by suitable measures.

## 1.6 NAMUR recommendations

NAMUR is the automation technology user association in the process industry in Germany. The published NAMUR recommendations are accepted as the standard in field instrumentation.

The device fulfils the requirements of the following NAMUR recommendations:

- NE 21 – Electromagnetic compatibility of equipment
- NE 43 – Signal level for fault information from measuring transducers
- NE 53 – Compatibility of field devices and display/adjustment components
- NE 107 – Self-monitoring and diagnosis of field devices

For further information see [www.namur.de](http://www.namur.de).

## 1.7 Radio license for Europe

The instrument was tested according to the latest issue of the following harmonized standards:

- EN 302372 - Tank Level Probing Radar

It is hence approved for use inside closed vessels in countries of the EU.

Use is also approved in EFTA countries, provided the respective standards have been implemented.

For operation inside of closed vessels, points a to f in annex E of EN 302372 must be fulfilled.

## 1.8 Radio license for USA

This approval is only valid for USA. Hence the following text is only available in the English language.

This device complies with Part 15 of the FCC Rules. Operation is subject to the following two conditions:

- This device may not cause interference, and
- This device must accept any interference, including interference that may cause undesired operation of the device

This device is approved for unrestricted use only inside closed, stationary vessels made of metal, reinforced fiberglass or concrete.

Changes or modifications not expressly approved by the manufacturer could void the user's authority to operate this equipment.

## 1.9 Environmental instructions

Protection of the environment is one of our most important duties. That is why we have introduced an environment management system with the goal of continuously improving company environmental protection. The environment management system is certified according to DIN EN ISO 14001.

Please help us fulfil this obligation by observing the environmental instructions in this manual:

- Chapter "*Packaging, transport and storage*"
- Chapter "*Disposal*"

## 2 Product description

### 2.1 Configuration

#### Type label

The type label contains the most important data for identification and use of the instrument:

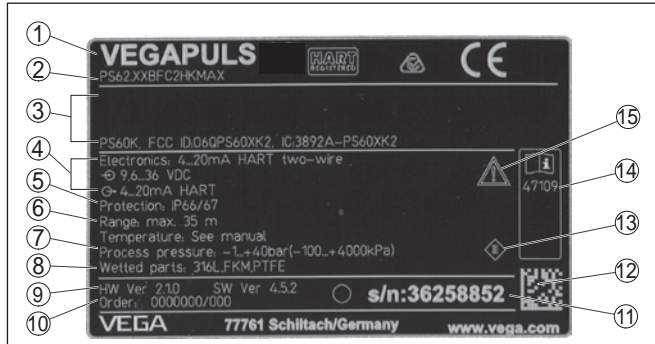

Fig. 1: Layout of the type label (example)

- 1 Instrument type
- 2 Product code
- 3 Approvals
- 4 Power supply and signal output, electronics
- 5 Protection rating
- 6 Measuring range (measurement reliability optional)
- 7 Process and ambient temperature, process pressure
- 8 Material wetted parts
- 9 Hardware and software version
- 10 Order number
- 11 Serial number of the instrument
- 12 Data matrix code for VEGA Tools app
- 13 Symbol of the device protection class
- 14 ID numbers, instrument documentation
- 15 Reminder to observe the instrument documentation

#### Serial number - Instrument search

The type label contains the serial number of the instrument. With it you can find the following instrument data on our homepage:

- Product code (HTML)
- Delivery date (HTML)
- Order-specific instrument features (HTML)
- Operating instructions and quick setup guide at the time of shipment (PDF)
- Order-specific sensor data for an electronics exchange (XML)
- Test certificate (PDF) - optional

Go to "[www.vega.com](http://www.vega.com)", "*Instrument search (serial number)*". Enter the serial number.

Alternatively, you can access the data via your smartphone:

- Download the VEGA Tools app from the "*Apple App Store*" or the "*Google Play Store*"
- Scan the Data Matrix code on the type label of the instrument or
- Enter the serial number manually in the app

**Scope of this operating instructions manual**

This operating instructions manual applies to the following instrument versions:

- Hardware from 2.1.0
- Software from 4.5.1

## 3 Mounting

### 3.1 Mounting instructions

#### Mounting

1. Distance from the vessel wall > 200 mm, the antenna should protrude > 10 mm into the vessel

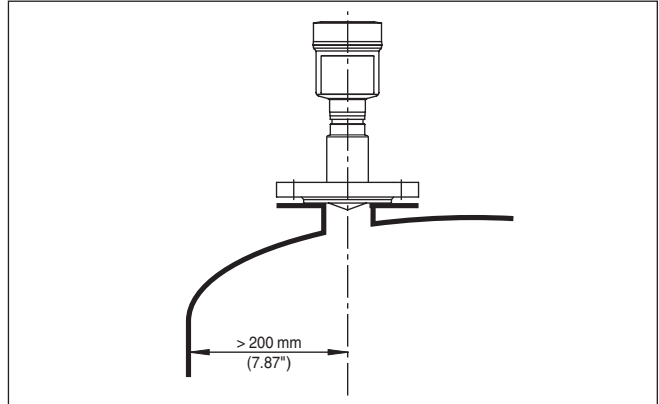

Fig. 2: Distance of the antenna to the vessel wall/vessel ceiling

2. Note min. socket diameter depending on the socket length  
For further information see chapter "Mounting".



## 4 Connecting to power supply

### 4.1 Connecting

#### Connection technology

The voltage supply and signal output are connected via the spring-loaded terminals in the housing.

Connection to the display and adjustment module or to the interface adapter is carried out via contact pins in the housing.



#### Information:

The terminal block is pluggable and can be removed from the electronics. To do this, lift the terminal block with a small screwdriver and pull it out. When reinserting the terminal block, you should hear it snap in.

#### Connection procedure

Proceed as follows:

1. Unscrew the housing lid
2. Loosen compression nut of the cable gland and remove blind plug
3. Remove approx. 10 cm (4 in) of the cable mantle (signal output), strip approx. 1 cm (0.4 in) insulation from the ends of the individual wires
4. Insert the cable into the sensor through the cable entry



Fig. 3: Connection steps 5 and 6

5. Insert the wire ends into the terminals according to the wiring plan



#### Information:

Solid cores as well as flexible cores with wire end sleeves are inserted directly into the terminal openings. In case of flexible cores without end sleeves, press the terminal from above with a small screwdriver, the terminal opening is then free. When the screwdriver is released, the terminal closes again.

6. Check the hold of the wires in the terminals by lightly pulling on them
7. Connect the cable screening to the internal ground terminal, connect the outer ground terminal to potential equalisation in case of power supply via low voltage
8. Connect the lead cable for power supply in the same way according to the wiring plan, in addition connect the ground conductor to the inner ground terminal when powered with mains voltage.
9. Tighten the compression nut of the cable glands. The seal ring must completely encircle the cables
10. Screw the housing lid back on

The electrical connection is finished.



#### Information:

The terminal blocks are pluggable and can be removed from the housing insert. To do this, lift the terminal block with a small screwdriver and pull it out. When inserting the terminal block again, you should hear it snap in.

## 4.2 Wiring plan, double chamber housing



The following illustrations apply to the non-Ex as well as to the Ex-d-ia version.

### Connection compartment with mains voltage

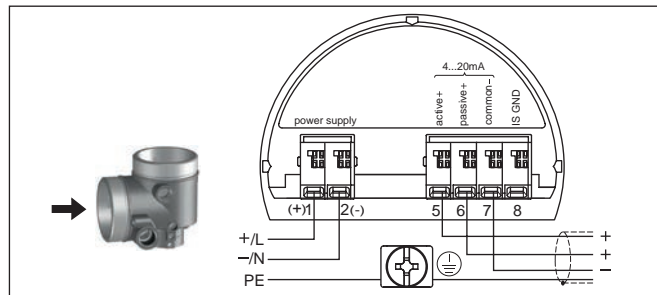

Fig. 4: Connection compartment with double chamber housing with mains voltage

Terminal	Function	Polarity
1	Voltage supply	+/L
2	Voltage supply	-/N
5	4 ... 20 mA output (active)	+
6	4 ... 20 mA output (passive)	+
7	Mass - output	-
8	Function ground when installing according to CSA (Canadian Standards Association)	

Connection compartment with low voltage

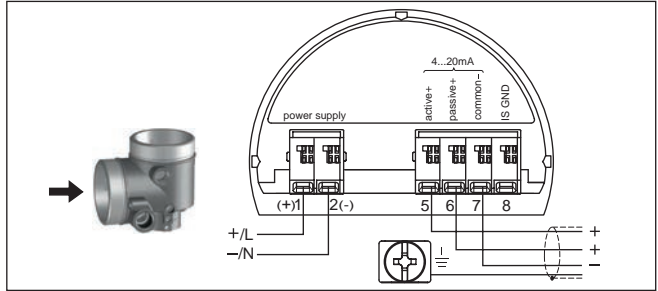

Fig. 5: Connection compartment with double chamber housing with low voltage

Terminal	Function	Polarity
1	Voltage supply	+/L
2	Voltage supply	-/N
5	4 ... 20 mA output (active)	+
6	4 ... 20 mA output (passive)	+
7	Mass - output	-
8	Function ground when installing according to CSA (Canadian Standards Association)	

## 5 Set up with the display and adjustment module

### 5.1 Insert display and adjustment module

The display and adjustment module can be inserted into the sensor and removed again at any time. You can choose any one of four different positions - each displaced by 90°. It is not necessary to interrupt the power supply.

Proceed as follows:

1. Unscrew the housing lid
2. Place the display and adjustment module on the electronics in the desired position and turn it to the right until it snaps in.
3. Screw housing lid with inspection window tightly back on

Disassembly is carried out in reverse order.

The display and adjustment module is powered by the sensor, an additional connection is not necessary.



Fig. 6: Installing the display and adjustment module in the double chamber housing



#### Note:

If you intend to retrofit the instrument with a display and adjustment module for continuous measured value indication, a higher lid with an inspection glass is required.

### 5.2 Parameter adjustment

#### Set parameters

1. Go to the menu "Setup" via the display and adjustment module.

```

Setup
Display
Diagnostics
Additional adjustments
Info
  
```

2. In the menu item "Medium" you select the medium of your application, for example "Aqueous solution".

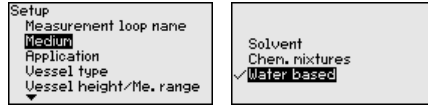

3. Select in the menu item "Application" the vessel, the application and the vessel form, for example, storage tank.

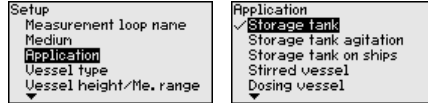

4. Carry out the adjustment in the menu items "Min. adjustment" and "Max. adjustment".

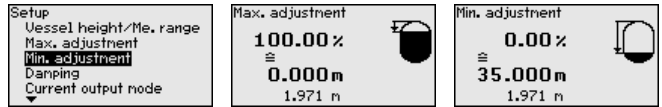

**Parameterization example** The radar sensor measures the distance from the sensor to the product surface. For indication of the real level, an allocation of the measured distance to the percentage height must be carried out.

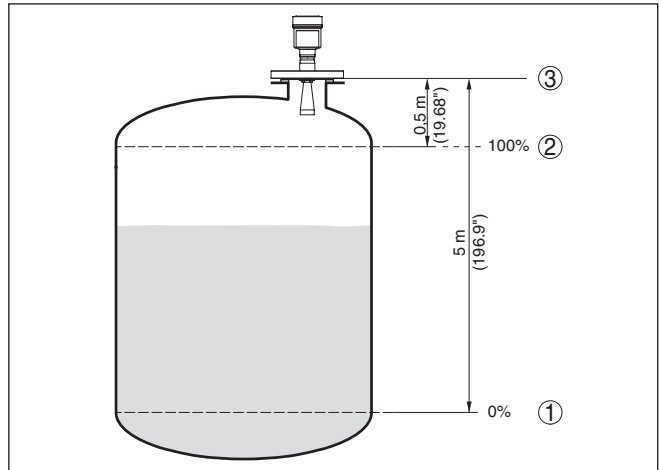

Fig. 7: Parameterisation example, Min./max. adjustment

- 1 Min. level = max. measuring distance
- 2 Max. level = min. measuring distance

For this adjustment, the distance is entered when the vessel is full and nearly empty. If these values are not known, an adjustment with other distances, for example, 10 % and 90 % is also possible. Starting point for these distance specifications is always the seal surface of the thread or flange.

**Diagnostics - Echo curve memory**

The function "Echo curve memory" makes it possible to save the echo curve at the time of setup. This is generally recommended, and

it is absolutely necessary if you want to use the Asset Management functions. If possible, the curve should be saved with a low level in the vessel.

With the adjustment software PACTware and a PC, a high resolution echo curve can be displayed and used to recognize signal changes during operation. In addition, the echo curve of setup can be displayed in the echo curve window and compared with the current echo curve.

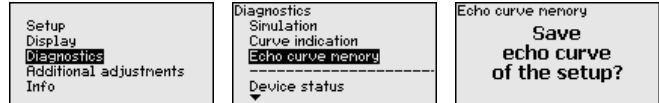

### Additional settings - False signal suppression

The following circumstances cause interfering reflections and can influence the measurement:

- High mounting sockets
- Vessel internals such as struts
- Agitators
- Buildup or welded joints on vessel walls



#### Note:

A false signal suppression detects, marks and saves these false signals to ensure that they are ignored in the level measurement.

This should be done with the lowest possible level so that all potential interfering reflections can be detected.

Proceed as follows:

1. Select with **[->]** the menu item "False signal suppression" and confirm with **[OK]**.

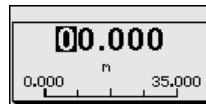
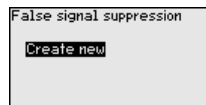
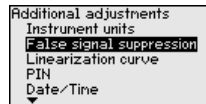

2. Confirm 3-times with **[OK]** and enter the actual distance from the sensor to the product surface.
3. All interfering signals in this range are detected by the sensor and stored after being confirmed with **[OK]**.



#### Note:

Check the distance to the product surface, because if an incorrect (too large) value is entered, the existing level will be saved as a false signal. The level would then no longer be detectable in this area.

If a false signal suppression has already been saved in the sensor, the following menu window appears when selecting "False signal suppression":



**Delete:** An already created false signal suppression will be completely deleted. This is useful if the saved false signal suppression no longer matches the metrological conditions in the vessel.

**Extend:** is used to extend an already created false signal suppression. This is useful if a false signal suppression was carried out with too high a level and not all false signals could be detected. When selecting "Extend", the distance to the product surface of the created false signal suppression is displayed. This value can now be changed and the false signal suppression can be extended to this range.

### 5.3 Menu overview

#### Setup

Menu item	Parameter	Default setting
Measurement loop name		Sensor
Medium		Liquid Water based
Application		Storage tank
Vessel form	Vessel top	Dished form
	Vessel bottom	Dished form
Vessel height/ Measuring range		35 m
Max. adjustment		0,000 m(d) 100.00 %
Min. adjustment		35 m 0.00 %
Damping	Integration time	0.0 s
Current output mode	Output characteristics	4 ... 20 mA
	Failure mode	≤ 3.6 mA
Current output - Min./Max.	Min. current	3.8 mA
	Max. current	20.5 mA
Lock adjustment		Released

#### Display

Menu item	Default setting
Language	Order-specific

Menu item	Default setting
Displayed value	Filling height in %
Backlight	Switched on

## Diagnosics

Menu item	Parameter	Default setting
Sensor status		-
Peak value	Distance	-
Electronics temperature	Temperature	-
Measurement reliability		-
Simulation		Percent
Curve indication	Echo curve	-
	False signal suppression	-
Echo curve memory		-

## Additional adjustments

Menu item	Default setting
Instrument units	Distance in m Temperature in °C
False signal suppression	-
Linearization	Linear
PIN	-
Date/Time	Actual date/Actual time
Reset	-
HART mode	Address 0
Copy instrument settings	-

## Info

Menu item	Parameter
Device name	VEGAPULS 6.
Instrument version	Hardware and software version
Date of manufacture	Date
Instrument features	Order-specific characteristics



## 6 Supplement

### 6.1 Technical data

#### Note for approved instruments

The technical data in the respective safety instructions are valid for approved instruments (e.g. with Ex approval). These data can differ from the data listed herein - for example regarding the process conditions or the voltage supply.

---

#### Electromechanical data - version IP 66/IP 67

---

Cable gland M20 x 1.5 or ½ NPT

Wire cross-section (spring-loaded terminals)

- Massive wire, stranded wire 0.2 ... 2.5 mm<sup>2</sup> (AWG 24 ... 14)
- Stranded wire with end sleeve 0.2 ... 1.5 mm<sup>2</sup> (AWG 24 ... 16)

---

#### Voltage supply

---

Operating voltage

- Version for low voltage 9.6 ... 48 V DC, 20 ... 42 V AC, 50/60 Hz
- Version for mains voltage 90 ... 253 V AC, 50/60 Hz

Reverse voltage protection Integrated

Max. power consumption 4 VA; 2.1 W





Printing date:

# VEGA

All statements concerning scope of delivery, application, practical use and operating conditions of the sensors and processing systems correspond to the information available at the time of printing.

Subject to change without prior notice

© VEGA Grieshaber KG, Schiltach/Germany 2018



47127-EN-180710

VEGA Grieshaber KG  
Am Hohenstein 113  
77761 Schiltach  
Germany

Phone +49 7836 50-0  
Fax +49 7836 50-201  
E-mail: [info.de@vega.com](mailto:info.de@vega.com)  
[www.vega.com](http://www.vega.com)