



## Safety instructions

### VEGAFLEX FX8\*.

**CC\*\*\*\*P/F\*\*\*\***

CSA No. 2515397 (LR 108043)

Ex [ia] IIC Ga; Class I Zone 0 AEx [ia] IIC Ga

Ex [ia] IIC Gb; Class I Zone 1 AEx [ia] IIC Gb

CL I, DIV 1, GP A,B,C,D

CL II, DIV 1, GP E,F,G

CL III

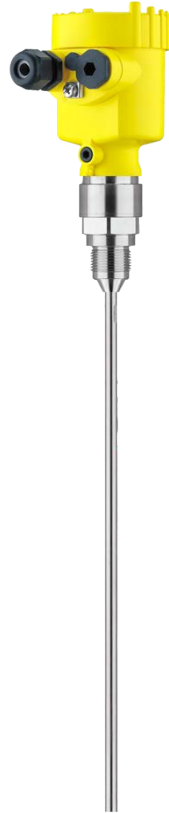

CE 0044



Document ID: 47736



**VEGA**

# Contents

<b>1</b>	<b>Area of applicability</b> .....	<b>3</b>
<b>2</b>	<b>General information</b> .....	<b>3</b>
<b>3</b>	<b>Technical data</b> .....	<b>4</b>
3.1	Supply and signal circuit.....	4
3.2	Intrinsically safe display and adjustment circuits .....	6
3.3	Intrinsically safe circuit for the display and adjustment module.....	7
3.4	Intrinsically safe HF circuit.....	8
<b>4</b>	<b>Application conditions</b> .....	<b>8</b>
<b>5</b>	<b>Protection against static electricity</b> .....	<b>11</b>
<b>6</b>	<b>Use of an overvoltage arrester</b> .....	<b>12</b>
<b>7</b>	<b>Installation of the sensors</b> .....	<b>12</b>
<b>8</b>	<b>Installation of the VEGAFLEX FX8*.CC****P/F**** with remote sensor</b> .....	<b>12</b>
<b>9</b>	<b>XX. versions with exchangeable cable or rod probe; versions with probe length "Length 0"</b> .....	<b>12</b>
<b>10</b>	<b>Grounding</b> .....	<b>12</b>
<b>11</b>	<b>Impact and friction sparks</b> .....	<b>12</b>
<b>12</b>	<b>Material resistance</b> .....	<b>13</b>
<b>13</b>	<b>Mounting with external indicating unit VEGADIS 61/81</b> .....	<b>13</b>
<b>14</b>	<b>Installation Diagram</b> .....	<b>13</b>
<b>15</b>	<b>Tensile force on the measuring cable/ rod</b> .....	<b>15</b>

Please note:

These safety instructions are part of the documentation:

- 44217 - VEGAFLEX 81 - Profibus PA
- 44214 - VEGAFLEX 81 - Coax probe - Profibus PA
- 44220 - VEGAFLEX 82 - Profibus PA
- 44226 - VEGAFLEX 83 - PFA isolated - Profibus PA
- 44223 - VEGAFLEX 83 - Polished version - Profibus PA
- 44232 - VEGAFLEX 86 - Profibus PA
- 44229 - VEGAFLEX 86 - Coax probe - Profibus PA
- 44218 - VEGAFLEX 81 - Foundation Fieldbus
- 44215 - VEGAFLEX 81 - Coax probe - Foundation Fieldbus
- 44221 - VEGAFLEX 82 - Foundation Fieldbus
- 44227 - VEGAFLEX 83 - PFA isolated - Foundation Fieldbus
- 44224 - VEGAFLEX 83 - Polished version - Foundation Fieldbus
- 44233 - VEGAFLEX 86 - Foundation Fieldbus
- 44230 - VEGAFLEX 86 - Coax probe - Foundation Fieldbus
- 49453 - CSA Certificate 2515397 (LR 108043)

## 1 Area of applicability

These safety instructions apply to the guided radar sensors VEGAFLEX FX81, VEGAFLEX FX82, VEGAFLEX FX83 and VEGAFLEX FX86 of series VEGAFLEX FX8\*.CC\*\*\*\*P/F\*\*\*\* according to CSA Certificate 2515397 (LR 108043) (certificate number on the type label) and to all instruments with the number of the safety instruction (47736) on the type label.

## 2 General information

The level measuring instrument VEGAFLEX FX8\*.CC\*\*\*\*P/F\*\*\*\*, based on the microwave measuring principle, is used to detect the distance between product surface and sensor by means of high frequency, electromagnetic waves in the GHz range. The electronics uses the running time of the signals reflected by the product surface to calculate the distance to the product surface.

The VEGAFLEX FX8\*.CC\*\*\*\*P/F\*\*\*\* consist of an electronics housing, a process connection element and a sensor, i.e. a measuring cable or a measuring rod. As an option, the display and adjustment module can also be installed in the instrument.

The VEGAFLEX FX8\*.CC\*\*\*\*P/F\*\*\*\* are suitable for use in hazardous atmospheres of all combustible materials of explosion group IIA, IIB and IIC for applications requiring instruments of EPL-Ga, EPL-Ga/Gb oder EPL-Gb.

The measured products can also be combustible liquids, gases, mist or vapour.

If the VEGAFLEX FX8\*.CC\*\*\*\*P/F\*\*\*\* are installed and operated in hazardous areas, the general Ex installation regulations IEC 60079-14 as well as these safety instructions must be observed.

The operating instructions as well as the installation regulations and standards that apply for explosion protection of electrical systems must always be observed.

The installation of explosion-endangered systems must always be carried out by qualified personnel.

### EPL-Ga instrument

The VEGAFLEX FX8\*.CC\*\*\*\*P/F\*\*\*\* are installed in hazardous areas requiring EPL-Ga instruments.

### EPL-Ga/Gb instrument

The electronics housing is installed in hazardous areas requiring instruments of type EPL-Gb. The process connection element is installed in the separating wall, which separates areas requiring instruments of type EPL-Ga or EPL-Gb. The sensor with the mechanical fixing element is installed in hazardous areas requiring instruments of type EPL-Ga.

### EPL-Gb instrument

The VEGAFLEX FX8\*.CC\*\*\*\*P/F\*\*\*\* are installed in hazardous areas requiring EPL-Gb instruments.

### 3 Technical data

#### 3.1 Supply and signal circuit

##### VEGAFLEX FX8\*.CC\*\*\*\*P/F\*A/K/V/8\*\*\*, single chamber housing, "Ex-i" electronics compartment

Power supply and signal circuit: (terminals 1[+], 2[-] in the "Ex-i" electronics compartment)

In ignition protection type intrinsic safety Ex ia IIC/IIB for instruments of category 1G or 1/2G and Ex ia IIC/IIB resp. Ex ib IIC/IIB for instruments of category 2G.

Only for connection to a certified, intrinsically safe circuit.

Maximum values:

- $U_i = 17.5 \text{ V}$
- $I_i = 500 \text{ mA}$
- $P_i = 5.5 \text{ W}$

The instrument is suitable for connection to a Fieldbus system according to the FISCO model (IEC 60079-11), e.g. Profibus PA.

or

- $U_i = 24 \text{ V}$
- $I_i = 250 \text{ mA}$
- $P_i = 1.2 \text{ W}$

The effective internal capacitance  $C_i$  is negligibly small.

In the version with permanently mounted connection cable,  $C_{i \text{ wire/wire}} = 58 \text{ pF/m}$  and  $C_{i \text{ wire/screen}} = 270 \text{ pF/m}$  must be taken into account.

The effective internal inductance  $L_i$  is negligibly small.

In the version with fix mounted connection cable,  $L_i = 0,55 \text{ } \mu\text{H/m}$  must be taken into consideration.

## VEGAFLEX FX8\*.CC\*\*\*\*P/F\*D/W/R/Y/Q/X\*\*\*, double chamber housing, "Ex-i" connection compartment

Power supply and signal circuit: (terminal 1[+], 2[-] in the "Ex-i" connection compartment)

In ignition protection type intrinsic safety Ex ia IIC/IIB for instruments of category 1G or 1/2G and Ex ia IIC/IIB resp. Ex ib IIC/IIB for instruments of category 2G.

Only for connection to a certified, intrinsically safe circuit.

Maximum values:

- $U_i = 17.5 \text{ V}$
- $I_i = 500 \text{ mA}$
- $P_i = 5.5 \text{ W}$

The instrument is suitable for connection to a Fieldbus system according to the FISCO model (IEC 60079-11), e.g. Profibus PA.

or

- $U_i = 24 \text{ V}$
- $I_i = 250 \text{ mA}$
- $P_i = 1.2 \text{ W}$

The effective internal capacitance  $C_i$  is negligibly small.

In the version with permanently mounted connection cable,  $C_{i \text{ wire/wire}} = 58 \text{ pF/m}$  and  $C_{i \text{ wire/screen}} = 270 \text{ pF/m}$  must be taken into account.

The effective internal inductance is  $L_i \leq 5 \text{ } \mu\text{H}$ .

In the version with fix mounted connection cable, also  $L_i = 0,55 \text{ } \mu\text{H/m}$  must be taken into consideration.

For applications requiring instruments of EPL-Gb, the intrinsically safe power supply and signal circuit can correspond to protection class ia or ib. For connection to a circuit with protection class ib, the ignition protection type identification is Ex ib IIC T6 ... T1.

For applications requiring equipment of type EPL-Ga or EPL-Ga/Gb, the intrinsically safe power supply and signal circuit must correspond to protection class ia.

For applications requiring instruments of type EPL-Ga resp. EPL-Ga/Gb the VEGAFLEX FX8\*.CC\*\*\*\*P/F\*\*\*\* is preferably connected to appropriate equipment with galvanically isolated, intrinsically safe circuits.

### 3.2 Intrinsically safe display and adjustment circuits

#### VEGAFLEX FX8\*.CC\*\*\*\*P/F\*A/K/V/8\*\*\*, single chamber housing, "Ex-i" electronics compartment

Display and adjustment circuit: (terminals 5, 6, 7, 8 in the "Ex-i" electronics housing or plug connection)

In ignition protection type intrinsic safety Ex ia IIC

For connection to the intrinsically safe circuit of the associated external indicating instrument VEGADIS 61/81 (IECEX PTB 06.0048 X).

The rules for the interconnection of intrinsically safe circuits between VEGAFLEX FX8\*.CC\*\*\*\*P/F\*A/K/V/8\*\*\* and the external display and adjustment unit VEGADIS 61/81 are fulfilled, provided that the total inductance and total capacitance of the connection cable between VEGAFLEX FX8\*.CC\*\*\*\*P/F\*A/K/V/8\*\*\* and the external display unit VEGADIS 61/81,  $L_{\text{cable}} = 212 \mu\text{H}$  and  $C_{\text{cable}} = 1.98 \mu\text{F}$ , is not exceeded.

When using the enclosed VEGA connection cable between VEGAFLEX FX8\*.CC\*\*\*\*P/F\*A/K/V/8\*\*\* and the external indicating unit VEGADIS 61/81, the following listed cable inductances  $L_i$  and cable capacitances  $C_i$  must be taken into account.

- $L_i = 0.62 \mu\text{H/m}$
- $C_{i \text{ wire/wire}} = 132 \text{ pF/m}$
- $C_{i \text{ wire/screen}} = 208 \text{ pF/m}$

#### VEGAFLEX FX8\*.CC\*\*\*\*P/F\*D/W/R\*\*\*, double chamber housing, "Ex-i" connection compartment

Indicating and adjustment circuit: (terminals 5, 6, 7, 8 in "Ex-i" electronics compartment)

In ignition protection type intrinsic safety Ex ia IIC

For connection to the intrinsically safe circuit of the associated external indicating instrument VEGADIS 61/81 (IECEX PTB 06.0048 X).

The rules for the interconnection of intrinsically safe circuits between VEGAFLEX FX8\*.CC\*\*\*\*P/F\*D/W/R\*\*\* and the external display and adjustment unit VEGADIS 61/81 are fulfilled, provided that the total inductance and total capacitance of the connection cable between VEGAFLEX FX8\*.CC\*\*\*\*P/F\*D/W/R\*\*\* and the external display unit VEGADIS 61/81,  $L_{\text{cable}} = 212 \mu\text{H}$  and  $C_{\text{cable}} = 1.98 \mu\text{F}$ , is not exceeded.

When using the enclosed VEGA connection cable between VEGAFLEX FX8\*.CC\*\*\*\*P/F\*D/W/R\*\*\* and the external indicating unit VEGADIS 61/81, the following listed cable inductances  $L_i$  and cable capacitances  $C_i$  must be taken into account.

- $L_i = 0.62 \mu\text{H/m}$
- $C_{i \text{ wire/wire}} = 132 \text{ pF/m}$
- $C_{i \text{ wire/screen}} = 208 \text{ pF/m}$

---

## VEGAFLEX FX8\*.CC\*\*\*\*P/F\*Y/Q/X\*\*\*, double chamber housing

---

Indicating and adjustment circuit:  
(terminals 5, 6, 7, 8 in "Ex-i" electronics  
compartment)

In ignition protection type intrinsic safety Ex ia IIC

and

Display and adjustment circuit: (plug con-  
nection in the "Ex-i" electronics compart-  
ment)

In ignition protection type intrinsic safety Ex ia IIC

Each for connection to the intrinsically safe circuit of  
the associated external indicating instrument VEGADIS  
61/81 (IECEX PTB 06.0048 X).

The rules for the interconnection of intrinsically safe  
circuits between VEGAFLEX FX8\*.CC\*\*\*\*P/F\*Y/Q/X\*\*\*  
and the external display and adjustment unit VEGADIS  
61/81 are fulfilled, provided that the total inductance  
and total capacitance of the connection cable between  
VEGAFLEX FX8\*.CC\*\*\*\*P/F\*Y/Q/X\*\*\* and the external  
display unit VEGADIS 61/81,  $L_{\text{cable}} = 212 \mu\text{H}$  and  $C_{\text{cable}} =$   
 $1.98 \mu\text{F}$ , is not exceeded.

When using the enclosed VEGA connection cable  
between VEGAFLEX FX8\*.CC\*\*\*\*P/F\*Y/Q/X\*\*\* and the  
external indicating unit VEGADIS 61/81, the following  
listed cable inductances  $L_i$  and cable capacitances  $C_i$   
must be taken into account.

- $L_i = 0.62 \mu\text{H/m}$
- $C_{i \text{ wire/wire}} = 132 \text{ pF/m}$
- $C_{i \text{ wire/screen}} = 208 \text{ pF/m}$

### 3.3 Intrinsically safe circuit for the display and adjustment module

---

#### VEGAFLEX FX8\*.CC\*\*\*\*P/F\*A/K/V/8\*\*\*, single chamber housing, "Ex-i" electronics compart- ment

---

Circuit for the display and adjustment  
module: (spring contacts in the "Ex-i"  
electronics compartment)

In ignition protection type intrinsic safety Ex ia IIC

For connection to the display and adjustment module  
PLICSCOM or VEGACONNECT.

---

#### VEGAFLEX FX8\*.CC\*\*\*\*P/F\*D/W/R\*\*\*, double chamber housing

---

Circuit for the display and adjustment  
module: (spring contacts in the "Ex-i"  
connection compartment)

In ignition protection type intrinsic safety Ex ia IIC

For connection to the display and adjustment module  
PLICSCOM or VEGACONNECT.

and

Circuit for the display and adjustment  
module: (spring contacts in the "Ex-i"  
electronics compartment)

In ignition protection type intrinsic safety Ex ia IIC

For connection to the display and adjustment module  
PLICSCOM or VEGACONNECT.

---

#### VEGAFLEX FX8\*.CC\*\*\*\*P/F\*Y/Q/X\*\*\*, double chamber housing, "Ex-i" connection compart- ment

---

Circuit for the display and adjustment  
module: (spring contacts in the "Ex-i"  
connection compartment)

In ignition protection type intrinsic safety Ex ia IIC

For connection to the display and adjustment module  
PLICSCOM or VEGACONNECT.

### 3.4 Intrinsically safe HF circuit

#### VEGAFLEX FX8\*.CC\*\*\*\*P/F\*\*\*\*

HF circuit

In ignition protection type intrinsic safety Ex ia IIC

The length of the coax connection cable between the electronics housing and the sensor housing may not exceed  $L_{\text{cable}} = 50 \text{ m}$  for all versions of VEGAFLEX FX8\*.CC\*\*\*\*P/F\*\*\*\* with separate sensor.

The intrinsically safe circuits of VEGAFLEX FX8\*.CC\*\*\*\*P/F\*\*\*\* are galvanically separated from each other and also against ground.

The metallic parts of VEGAFLEX FX8\*.CC\*\*\*\*P/F\*\*\*\* are electrically connected with the internal and external earth terminal.

## 4 Application conditions

The max. permissible ambient temperatures depending on the temperature classes are specified in the following table.

#### EPL-Ga instrument

Temperature class	Temperature on the sensor (measuring cable, rod)	Ambient temperature on the electronics
T5	-20 ... +44 °C	-20 ... +44 °C
T4, T3, T2, T1	-20 ... +60 °C	-20 ... +60 °C

The process pressure of the medium must be between 0.8 ... 1.1 bar for applications requiring EPL-Ga instruments. The permissible operating temperatures and pressures for operation are listed in the manufacturer specification.

#### EPL-Ga/Gb instrument

Temperature class	Temperature on the sensor (measuring cable, rod)	Ambient temperature on the electronics
T6	-20 ... +60 °C	-50 ... +48 °C
T5	-20 ... +60 °C	-50 ... +63 °C
T4, T3, T2, T1	-20 ... +60 °C	-50 ... +70 °C

For applications requiring EPL-Ga/Gb instruments the process pressure of the media must be between 0.8 ... 1.1 bar. If the VEGAFLEX FX8\*.CC\*\*\*\*P/F\*\*\*\* are operated at temperatures higher than those specified in the above table, please make sure through appropriate measures that there is no danger of ignition from the hot surfaces. The maximum temperature on the electronics/housing should not exceed the values specified in the above table. The application conditions during operation in areas with no explosive mixtures are stated in the manufacturer information.

#### EPL-Gb / Division 1 instrument

Temperature class	Temperature on the sensor (measuring cable, rod)	Ambient temperature on the electronics
T6	-60 ... +85 °C	-50 ... +48 °C
T5	-60 ... +100 °C	-50 ... +63 °C
T4	-60 ... +135 °C	-50 ... +70 °C



Temperature class	Temperature on the sensor (measuring cable, rod)	Ambient temperature on the electronics
T3	-60 ... +200 °C	-50 ... +70 °C
T2	-60 ... +300 °C	-50 ... +70 °C
T1	-60 ... +450 °C	-50 ... +70 °C

If the VEGAFLEX FX8\*.CC\*\*\*\*P/F\*\*\*\* are operated at temperatures higher than those specified in the above table, please make sure through appropriate measures that there is no danger of ignition from the hot surfaces. The maximum temperature on the electronics/housing should not exceed the values specified in the above table. The permissible operating temperatures and pressures are stated in the manufacturer information.

## VEGAFLEX FX86.CC\*\*\*\*A/HZ\*\*\*\*, low temperature version down to -196 °C

### EPL-Gb / Division 1 instrument

Temperature class	Temperature on the sensor (measuring cable, rod)	Ambient temperature on the electronics
T6	-196 ... +85 °C	-50 ... +48 °C
T5	-196 ... +100 °C	-50 ... +63 °C
T4	-196 ... +135 °C	-50 ... +70 °C
T3	-196 ... +200 °C	-50 ... +70 °C
T2	-196 ... +300 °C	-50 ... +70 °C
T1	-196 ... +450 °C	-50 ... +70 °C

If the VEGAFLEX FX86.CC\*\*\*\*A/HZ\*\*\*\* are operated at temperatures higher than those specified in the above table, please make sure through appropriate measures that there is no danger of ignition from the hot surfaces. The maximum temperature on the electronics/housing should not exceed the values specified in the above table. The permissible operating temperatures and pressures are stated in the manufacturer information.

### Temperature derating for process temperatures up to +150 °C, +200 °C, +250 °C, +280 °C and +450 °C

### Versions for process temperatures up to +150 °C with plastic housing

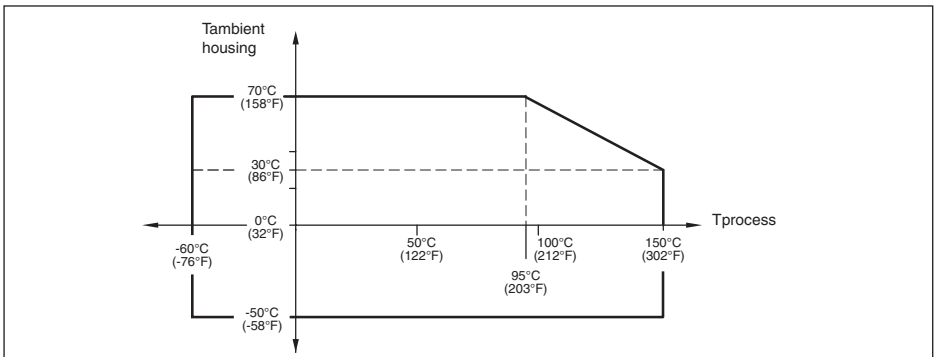

**Versions for process temperatures up to +150 °C with metal housing**

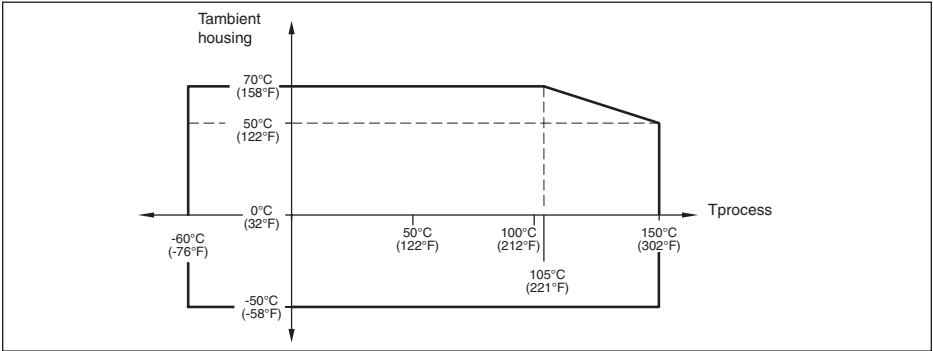

**Versions for process temperatures up to +200 °C with plastic housing**

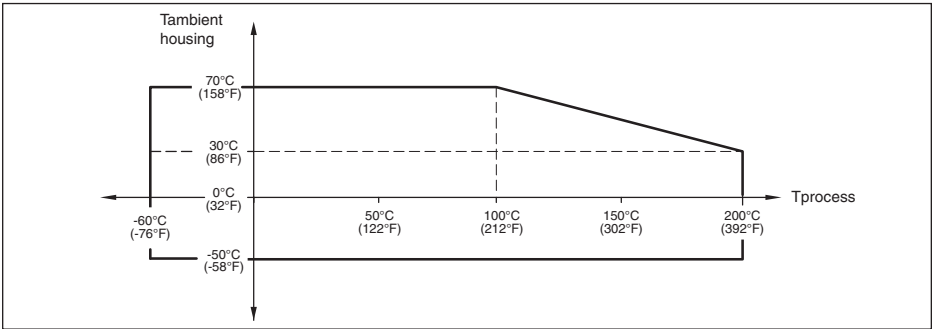

**Versions for process temperatures up to +200 °C with metal housing**

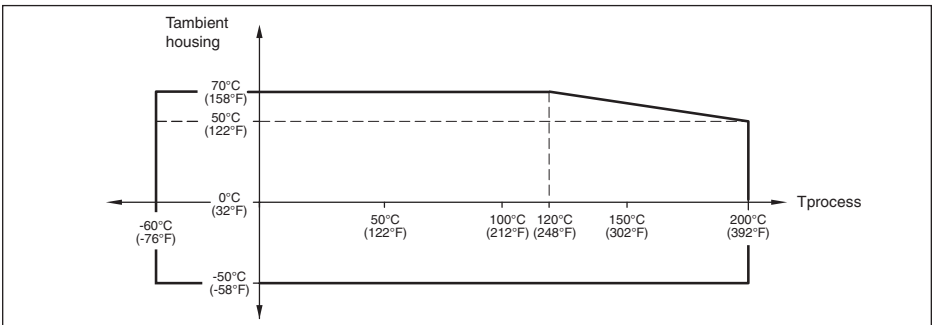

## Versions for process temperatures up to +280 °C with plastic housing

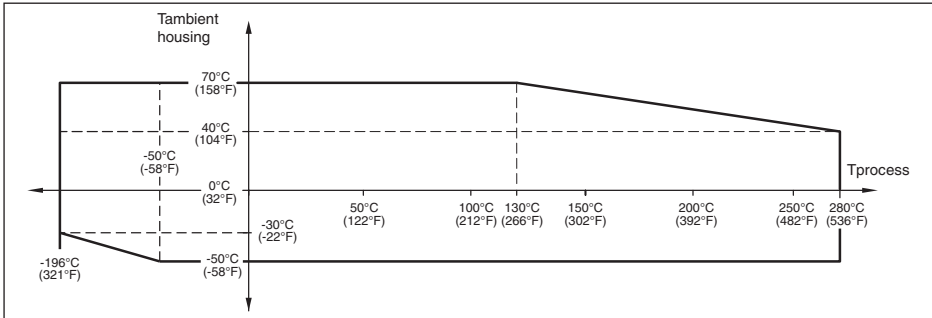

## Versions for process temperatures up to +280 °C with metal housing

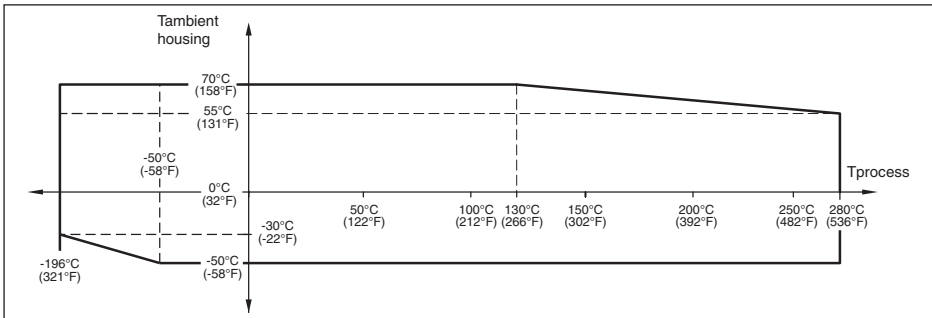

## Versions for process temperatures up to +450 °C with plastic and metal housing

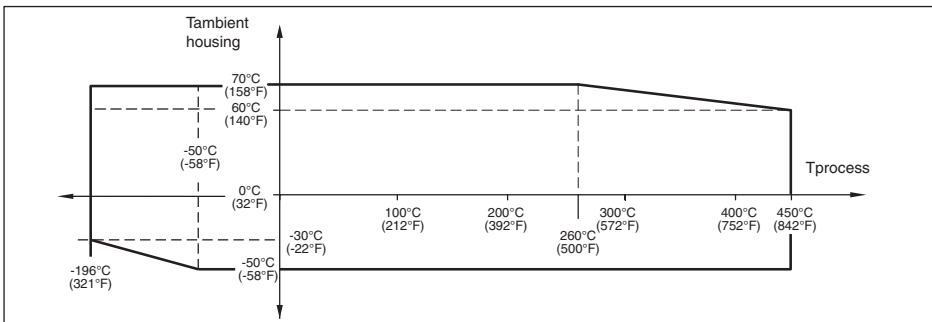

## 5 Protection against static electricity

The VEGAFLEX FX8\*.CC\*\*\*\*P/F\*\*\*\* in the version with chargeable plastic parts, like e.g. plastic housing, metal housing with inspection window or plastic-coated measuring cable/ rod, are provided with a caution label referring to the safety measures that must be taken in case of electrostatic charging during operation.



Caution: Plastic parts! Danger of electrostatic charging!

- Avoid friction
- No dry cleaning
- Do not mount in areas with flowing, non-conductive products

## 6 Use of an overvoltage arrester

If necessary, the VEGAFLEX FX8\*.CC\*\*\*\*P/F\*\*\*\* can be connected to an overvoltage arrester, e. g. type B62-36G from VEGA.

When used as EPL-Ga or EPL-Ga/Gb instrument, a suitable overvoltage arrester, e. g. type B62-36G of VEGA (IECEX TUN 07.0002) must be connected as far as this is required according to IEC 60079-14 chapter 12.3, for protection against surges.

## 7 Installation of the sensors

When used as EPL-Ga or EPL-Ga/Gb instruments, the sensors of VEGAFLEX FX8\*.CC\*\*\*\*P/F\*\*\*\* should be mounted such that the measuring cable/rod is effectively secured against bending or touching the vessel wall, under consideration of other vessel installations and flow conditions in the vessel. This applies especially to measuring probes over 3 m long.

## 8 Installation of the VEGAFLEX FX8\*.CC\*\*\*\*P/F\*\*\*\* with remote sensor

With the version VEGAFLEX FX8\*.CC\*\*\*\*P/F\*\*\*\* with remote sensor, make sure that the coaxial connection cable between electronics housing and sensor housing cannot get damaged.

## 9 XX. versions with exchangeable cable or rod probe; versions with probe length "Length 0"

The following must be taken into account for VEGAFLEX FX8\*.CC\*\*\*\*P/F\*\*\*\* versions with exchangeable cable or rod probe and for VEGAFLEX FX8\*.CC\*\*\*\*P/F\*\*\*\* versions probe length "Length 0":

- On certified VEGAFLEX FX8\*.CC\*\*\*\*P/F\*\*\*\* only original VEGA cable or rod probes must be mounted
- When mounting cable or rod probes, the torques specified in the respective operating instruction manuals must be maintained
- The mechanical connection must be ensured

## 10 Grounding

In order to avoid the danger of electrostatic charging of the metallic parts, the VEGAFLEX FX8\*.CC\*\*\*\*P/F\*\*\*\* must be electrostatically connected to the local potential equalisation (transfer resistance  $\leq 1 \text{ M}\Omega$ ), e.g. via the ground terminal, when used as EPL-Ga instrument or EPL-Ga/Gb instrument.

## 11 Impact and friction sparks

When used as EPL-Ga or EPL-Ga/Gb instruments, the VEGAFLEX FX8\*.CC\*\*\*\*P/F\*\*\*\* in aluminium/titanium versions must be mounted in such a way that sparks from impact and friction

between aluminium/titanium and steel (except stainless steel, if the presence of rust particles can be excluded) cannot occur.

## 12 Material resistance

For applications requiring instruments of type EPL-Ga or EPL-Ga/Gb the VEGAFLEX FX8\*.CC\*\*\*\*P/F\*\*\*\* must only be used in products against which the wetted materials are sufficiently resistant.

## 13 Mounting with external indicating unit VEGADIS 61/81

The intrinsically safe signal circuit between VEGAFLEX FX8\*.CC\*\*\*\*P/F\*\*\*\* and the external indicating unit VEGADIS 61/81 should be set up without grounding. The required insulation voltage is > 500 V AC. When using the VEGA connection cable included with the delivery, this requirement is fulfilled. If grounding of the cable screen is required, it must be carried out according to IEC 60079-14 paragr. 12.2.2.3.

## 14 Installation Diagram

### Installation Control Diagram

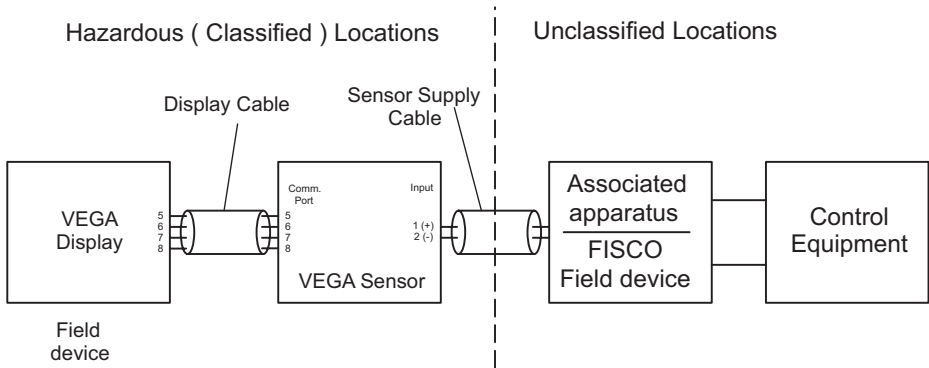

Fig. 9: VEGAFLEX FX8\*(\*).CC\*\*\*\*P/F\*\*\*\* - Single chamber housing

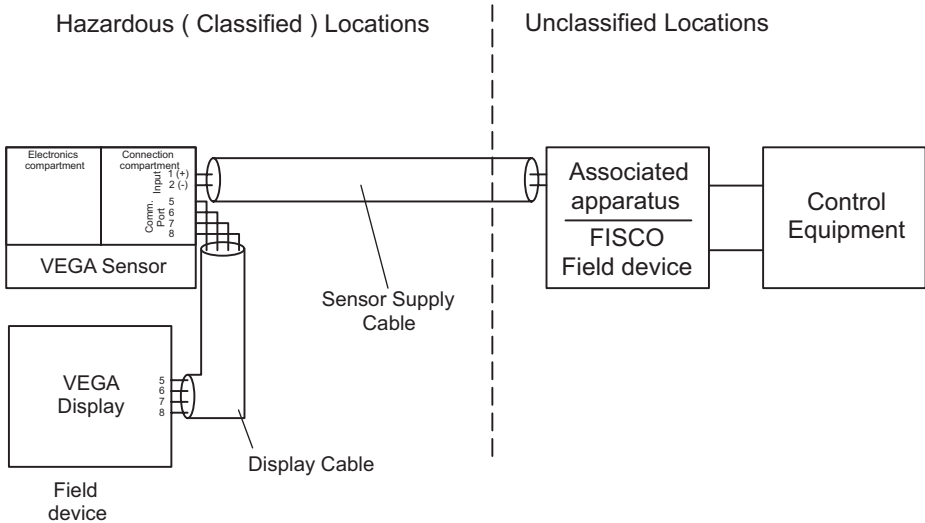

Fig. 10: VEGAFLEX FX8\*(\*) .CC\*\*\*\*P/F\*\*\*\*\* - Double chamber housing

**General**

The Intrinsic Safety Entity concept allows the interconnection of two intrinsically safe devices FM Approved and CSA Certified when installed in Canada with entity parameters not specifically examined in combination as a system when:

$$U_o \text{ or } V_{oc} \text{ or } V_t \leq V_{max}$$

$$I_o \text{ or } I_{sc} \text{ or } I_t \leq I_{max}$$

$$P_o \leq P_i$$

$$C_a \text{ or } C_o \geq C_{cable}$$

$$L_a \text{ or } L_o \geq L_{cable}$$

For Division 2 installations, the Associated Apparatus is required to be Fm approved or CSA Certified when installed in Canada under Entity Concept if the VEGAFLEX 80 Series is installed in accordance with the National Electrical Code ® (ANSI/NFPA 70) or Canadian Electrical Code, CSA C22.1 Part 1 Appendix F, for division 2 wiring methods excluding Nonincendive field wiring.

Dust-tight conduit seal shall be used when installed in Class II and Class III environments.

Division 1 installations should be in accordance with ANSI/ISA RP12.06.01 "Installation of Intrinsically Safe Systems for Hazardous (Classified) Locations" and the National Electrical Code ® (ANSI/NRPA 70) or Canadian Electrical Code.

The configuration of Field Device must be FM Approved / CSA Certified under Entity Concept.

The Field Device manufacturer's installation drawing shall be followed when installing this equipment.

The VEGAFLEX Series are FM Approved / CSA Certified for Class I, Zone 0, application. If connecting [Ex ib] / [AEx ib] Associated Apparatus or Ex ib / AEx ib I.S. Field Device to the VEGAFLEX Series, the above system is only suitable for Class I, Zone 1, and is not suitable for Class I, Zone 0 Hazardous (Classified) Locations.

**WARNING:** Substitution of components may impair suitability for hazardous locations.

Barriers and instruments to carry same Agency Approval.

## Control Equipment

Control equipment connected to the Associated Apparatus shall not use or generate more than 253 Vrms or Vdc.

## Associated Apparatus

For Division 1 installations, the configuration of associated Apparatus shall be FM approved / CSA Certified under Entity Concept.

Associated Apparatus manufacturer's installation drawing shall be followed when installing this equipment.

The VEGAFLEX Series are FM Approved / CSA Certified for Class I, Zone 0, application. If connecting [Ex ib] / [AEx ib] Associated Apparatus or Ex ib / AEx ib I.S. Field Device to the VEGAFLEX Series, the above system is only suitable for Class I, Zone 1, and is not suitable for Class I, Zone 0 Hazardous (Classified) Locations.

## VEGA Display

The VEGA Display is a VEGADIS 61 or VEGADIS 81.

The configuration of Field Device must be FM Approved / CSA Certified under Entity Concept.

The Field Device manufacturer's installation drawing shall be followed when installing this equipment.

The VEGAFLEX Series are FM Approved / CSA Certified for Class I, Zone 0, application. If connecting [Ex ib] / [AEx ib] Associated Apparatus or Ex ib / AEx ib I.S. Field Device to the VEGAFLEX Series, the above system is only suitable for Class I, Zone 1, and is not suitable for Class I, Zone 0 Hazardous (Classified) Locations.

## Display Cable

The regulations for the interconnection of intrinsically safe circuits between VEGAFLEX FX8\*.CC\*\*\*\*P/F\*\*\*\* and the external indication and adjustment unit are complied with if the total inductance and total capacity of the connection cable between VEGAFLEX FX8\*.CC\*\*\*\*P/F\*\*\*\* and the external indication and adjustment unit  $L_{\text{cable}} = 100 \mu\text{H}$  and  $C_{\text{cable}} = 1.98 \mu\text{F}$  are not exceeded. The indication and adjustment module integrated in VEGAFLEX FX8\*.CC\*\*\*\*P/F\*\*\*\* and the connected interface converter are taken into account.

In case of using the display connection cable delivered from VEGA between the VEGAFLEX FX8\*.CC\*\*\*\*P/F\*\*\*\* and the display VEGADIS 61 or VEGADIS 81 the following parameters has to be considered:

$$L'_i = 0.62 \mu\text{H/m}$$

$$C'_{i \text{ wire/wire}} = 132 \text{ pF/m}$$

$$C'_{i \text{ wire/screen}} = 208 \text{ pF/m}$$

## 15 Tensile force on the measuring cable/ rod

The permissible tensile force is

- VEGAFLEX FX81.CC\*\*\*\*P/F\*\*\*\*
  - Diameter 4 mm: F = 2.5 kN
  - Diameter 2 mm: F = 1.5 kN
- VEGAFLEX FX82.CC\*\*\*\*P/F\*\*\*\*
  - Diameter 4 mm: F = 12 kN
  - Diameter 6 mm coated: F = 8 kN
  - Diameter 6 mm: F = 30 kN
  - Diameter 11 mm coated: F = 30 kN
- VEGAFLEX FX83.CC\*\*\*\*P/F\*\*\*\*
  - Diameter 4 mm: F = 2 kN

- 
- VEGAFLEX FX86.CC\*\*\*\*P/F\*\*\*\*
    - Diameter 4 mm: F = 2.5 kN
    - Diameter 2 mm: F = 1.5 kN





47736-EN-150429

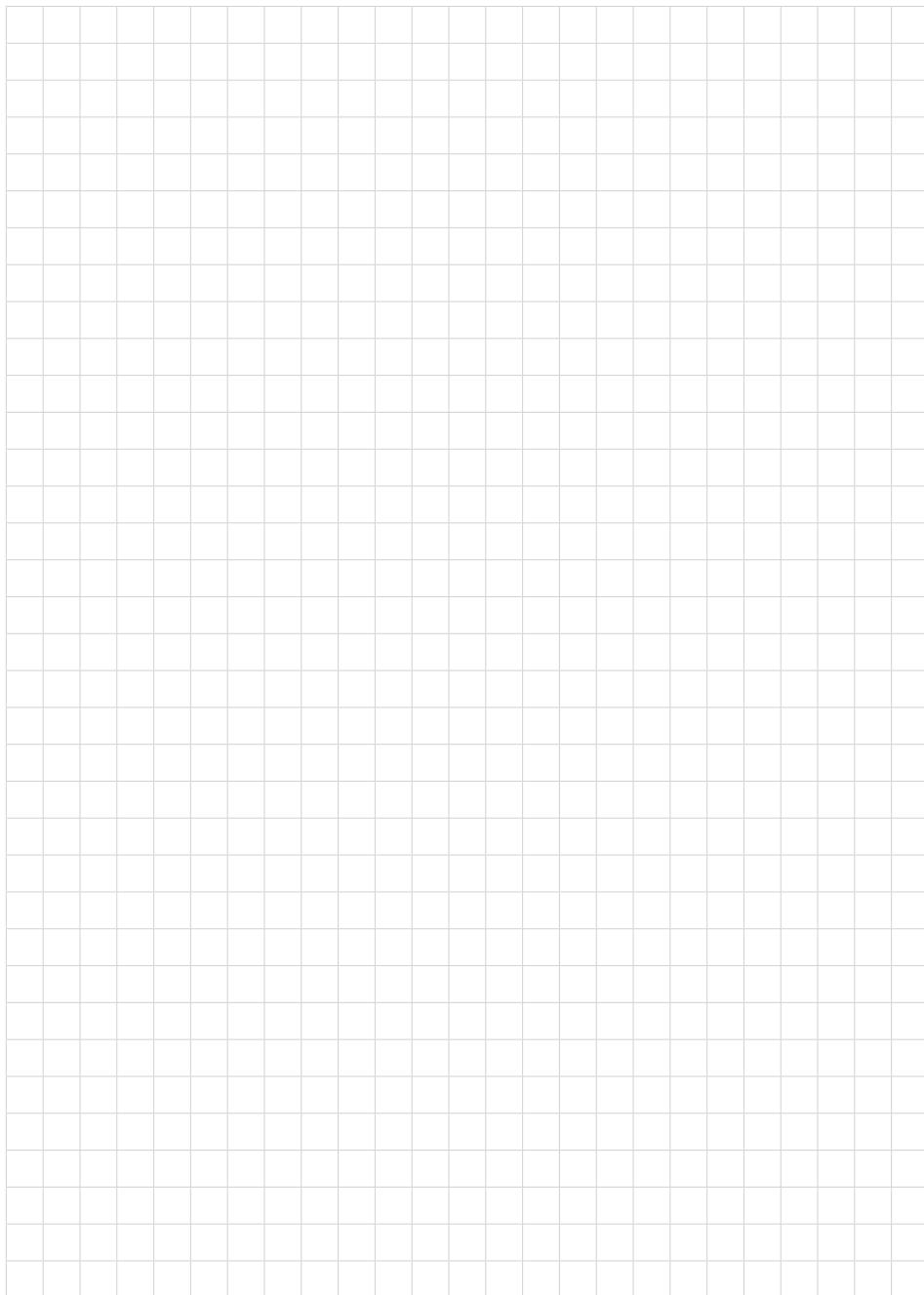



47736-EN-150429

Printing date:

# VEGA

All statements concerning scope of delivery, application, practical use and operating conditions of the sensors and processing systems correspond to the information available at the time of printing.

Subject to change without prior notice

© VEGA Grieshaber KG, Schiltach/Germany 2015



47736-EN-150429

VEGA Grieshaber KG  
Am Hohenstein 113  
77761 Schiltach  
Germany

Phone +49 7836 50-0  
Fax +49 7836 50-201  
E-mail: [info.de@vega.com](mailto:info.de@vega.com)  
[www.vega.com](http://www.vega.com)